

PAJUNK®



REGIONAL ANAESTHESIA
& PAIN MANAGEMENT

Pain Management Product Catalogue

Table of Contents

1 | INJECTIONS

| | |
|-----------------------|----|
| <i>SonoMSK</i> | 4 |
| <i>UniMSK</i> | 5 |
| <i>TuohySono</i> | 6 |
| <i>Tuohy</i> | 7 |
| <i>Curved Sprotte</i> | 8 |
| <i>RGN</i> | 9 |
| <i>VPC & LOR</i> | 10 |

2 | RF ABLATION

| | |
|--------------------|----|
| <i>RFTL</i> | 12 |
| <i>RFTL Curved</i> | 13 |
| <i>RFTL Sono</i> | 14 |
| <i>PulsedRF</i> | 15 |
| <i>AlliClip</i> | 16 |

Injections

Ultrasound and Fluoroscopy Guided Steroid
& Anaesthetic Injection Needles

SonoMSK

Sharp, Echogenic MSK and Chronic Pain Injection Needle

- 1 Echogenic Needle Tip
- 2 Cornerstone Reflectors
- 3 Sharp Back Cut Bevel
- 4 Depth Markings
- 5 Pre-attached & Removable Injection Tubing

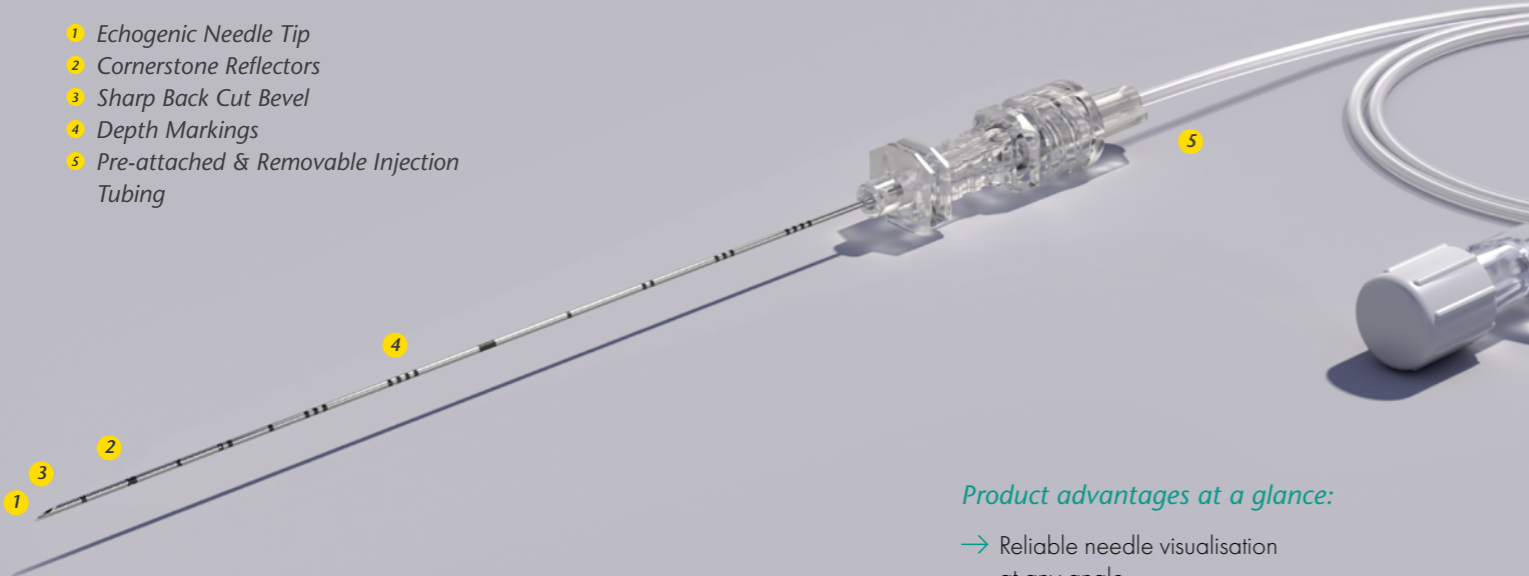

Product advantages at a glance:

- Reliable needle visualisation at any angle
- Optimised ultrasound visibility of needle shaft
- Reduced pain during puncture and needle placement
- Smooth gliding properties
- Easier and more precise needle maneuverability
- Convenience

| Description | Item no. | PU |
|-----------------------|------------|----|
| 22G x 25 mm (1") | 1191-4E025 | 10 |
| 22G x 40 mm (1 5/8") | 1191-4E040 | 10 |
| 22G x 70 mm (2 3/4") | 1191-4E070 | 10 |
| 22G x 90 mm (3 1/2") | 1191-4E090 | 10 |
| 22G x 100 mm (4") | 1191-4E100 | 10 |
| 22G x 120 mm (4 3/4") | 1191-4E120 | 10 |
| 22G x 150 mm (6") | 1191-4E150 | 10 |

UniMSK

Sharp MSK and Chronic Pain Injection Needle

- 1 Sharp Back Cut Bevel
- 2 Depth Markings
- 3 Pre-attached & Removable Injection Tubing

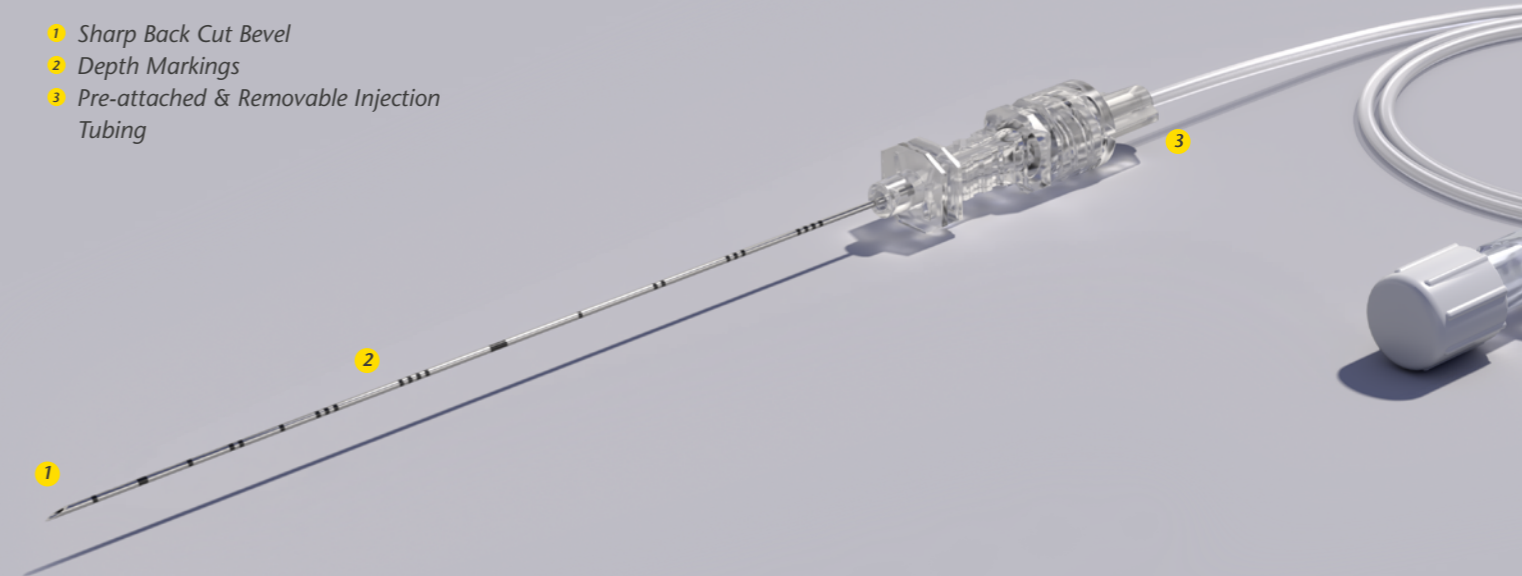

Product advantages at a glance:

- Reduced pain during puncture and needle placement
- Smooth gliding properties
- Easier and more precise needle maneuverability
- Convenience

| Description | Item no. | PU |
|-----------------------|------------|----|
| 22G x 40 mm (1 5/8") | 1192-4E040 | 10 |
| 22G x 70 mm (2 3/4") | 1192-4E070 | 10 |
| 22G x 100 mm (4") | 1192-4E100 | 10 |
| 22G x 120 mm (4 3/4") | 1192-4E120 | 10 |
| 22G x 150 mm (6") | 1192-4E150 | 10 |
| 22G x 180 mm (7 1/5") | 1192-4E180 | 10 |

| Description | Item no. | PU |
|-----------------------|------------|----|
| 20G x 100 mm (4") | 1192-4G100 | 10 |
| 20G x 120 mm (4 3/4") | 1192-4G120 | 10 |
| 20G x 150 mm (6") | 1192-4G150 | 10 |
| 20G x 180 mm (7 1/5") | 1192-4G180 | 10 |
| 18G x 100 mm (4") | 1192-4K100 | 10 |
| 18G x 120 mm (4 3/4") | 1192-4K120 | 10 |
| 18G x 150 mm (6") | 1192-4K150 | 10 |

TuohySono

Echogenic, Non-Stimulating Single Shot Fascial Plane Block Needle

- 1 Echogenic Needle Tip
- 2 Cornerstone Reflectors
- 3 Depth Markings
- 4 Precision-Ground Metal Stylet
- 5 Detachable Plastic Wings

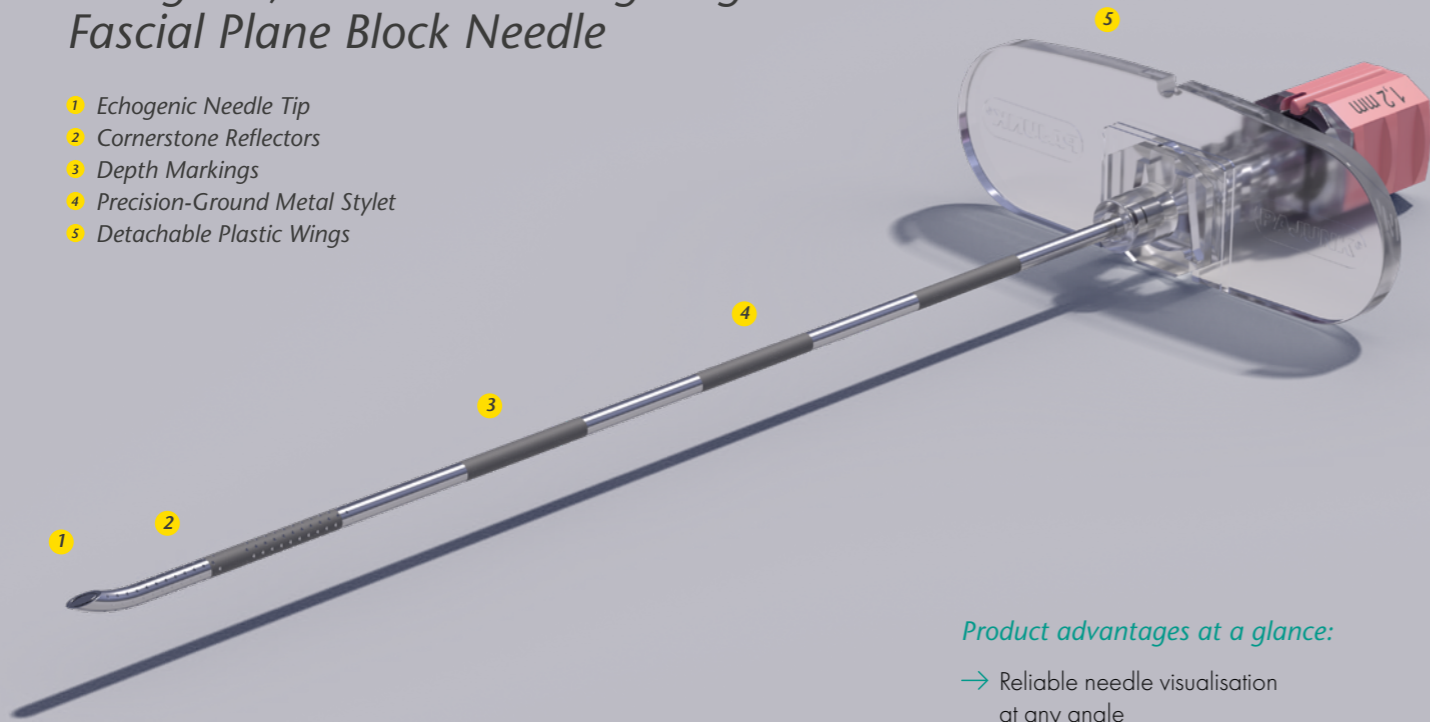

Product advantages at a glance:

- Reliable needle visualisation at any angle
- Optimised ultrasound visibility of needle shaft
- Minimised tissue coring
- Smooth gliding properties
- Optimum handling for different gripping techniques

| Description | Item no. | PU |
|-----------------------|------------|----|
| 20G x 103 mm (4") | 1085-4G103 | 25 |
| 18G x 50 mm (2") | 1085-4K050 | 25 |
| 18G x 90 mm (3 1/2") | 1085-4K090 | 25 |
| 18G x 120 mm (4 3/4") | 1085-4K120 | 10 |
| 18G x 150 mm (6") | 1085-4K150 | 10 |
| 17G x 90 mm (3 1/2") | 1085-4M090 | 25 |
| 17G x 150 mm (6") | 1085-4M150 | 10 |

Tuohy

Non-Stimulating Single Shot Fascial Plane Block Needle

- 1 Depth Markings
- 2 Precision-Ground Metal Stylet
- 3 Detachable Plastic Wings

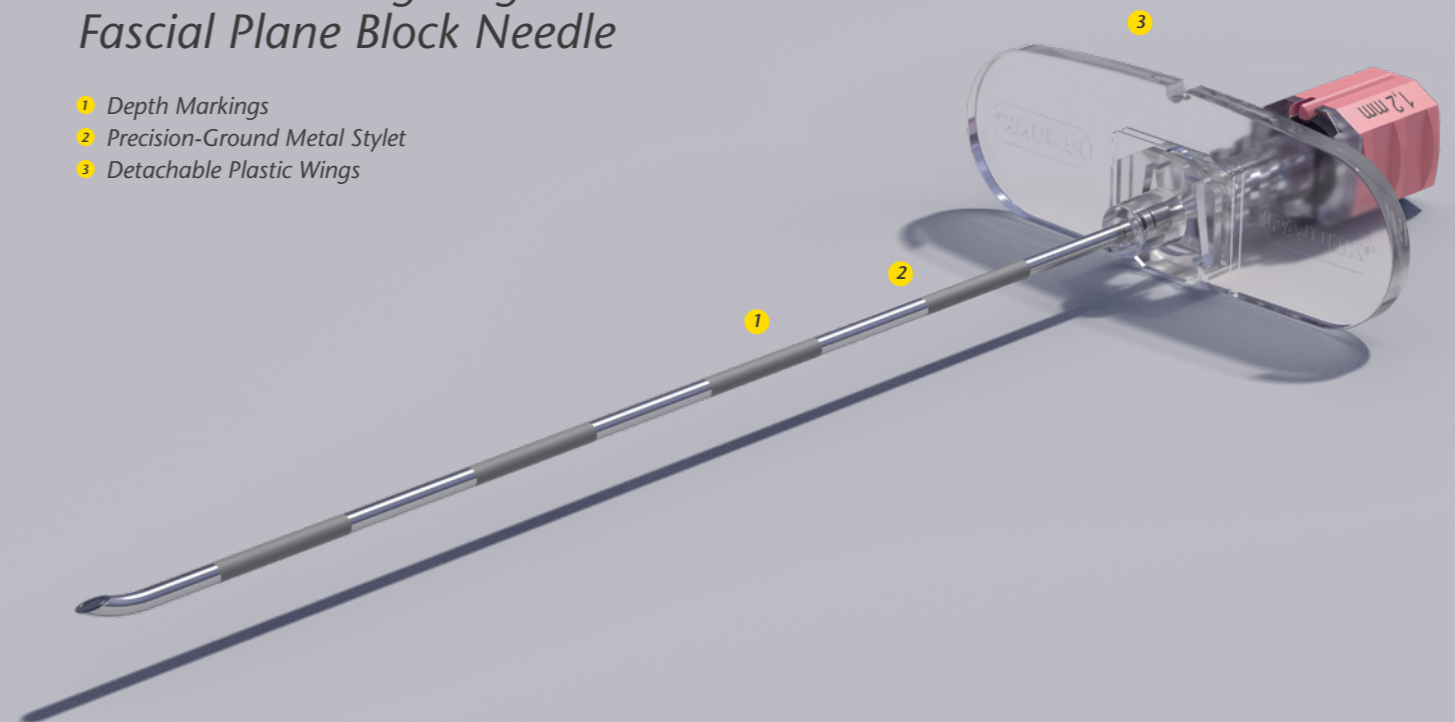

Product advantages at a glance:

- Minimised tissue coring
- Smooth gliding properties
- Optimum handling for different gripping techniques

| Description | Item no. | PU |
|-----------------------|------------|----|
| 20G x 90 mm (3 1/2") | 1150-4G090 | 25 |
| 20G x 100 mm (4") | 1150-4G103 | 25 |
| 20G x 120 mm (4 3/4") | 1150-4G120 | 10 |
| 20G x 150 mm (6") | 1150-4G150 | 10 |
| 19G x 90 mm (3 1/2") | 1150-4I090 | 25 |
| 18G x 50 mm (2") | 1150-4K050 | 25 |
| 18G x 80 mm (3 1/4") | 1150-4K080 | 25 |
| 18G x 90 mm (3 1/2") | 1150-4K090 | 25 |
| 18G x 100 mm (4") | 1150-4K100 | 25 |

| Description | Item no. | PU |
|-----------------------|------------|----|
| 18G x 120 mm (4 3/4") | 1150-4K120 | 10 |
| 18 G x 150 mm (6") | 1150-4K150 | 10 |
| 18G x 200 mm (8") | 1150-4K200 | 10 |
| 17G x 90 mm (3 1/2") | 1150-4M090 | 25 |
| 17G x 100 mm (4") | 1150-4M100 | 25 |
| 17G x 120 mm (4 3/4") | 1150-4M120 | 10 |
| 17G x 150 mm (6") | 1150-4M150 | 10 |
| 17G x 200 mm (8") | 1150-4M200 | 10 |

Curved SPROTTE®

Curved Injection Needle with Atraumatic Tip Design

- 1 Atraumatic Tip Design
- 2 Curved Tip Geometry
- 3 Highest Processing Quality
- 4 Detachable Plastic Wings

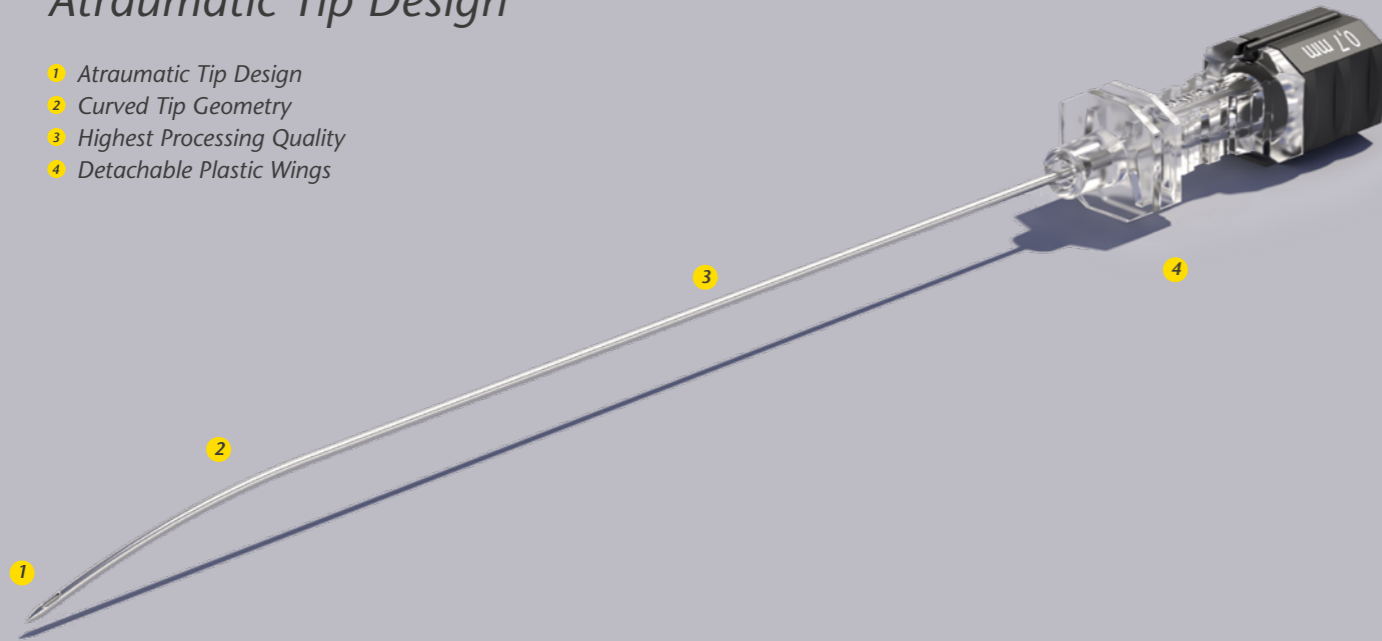

Product advantages at a glance:

- Atraumatic tip design allows for atraumatic spinal anaesthesia
- Smooth gliding properties and improved tactile feedback
- Optimum handling for different gripping techniques

| Description | Item no. | PU |
|----------------------|------------|----|
| 22G x 90mm (3 1/3") | 001152-30C | 25 |
| 22G x 120mm (4 3/4") | 031152-30C | 10 |
| 22G x 150mm (6") | 041152-30C | 10 |

RGN

Hubless Contrast Injection Needle

- 1 Hubless Design
- 2 Fixed Injection Tubing
- 3 Sharp Facet Tip
- 4 Smooth Needle Surface

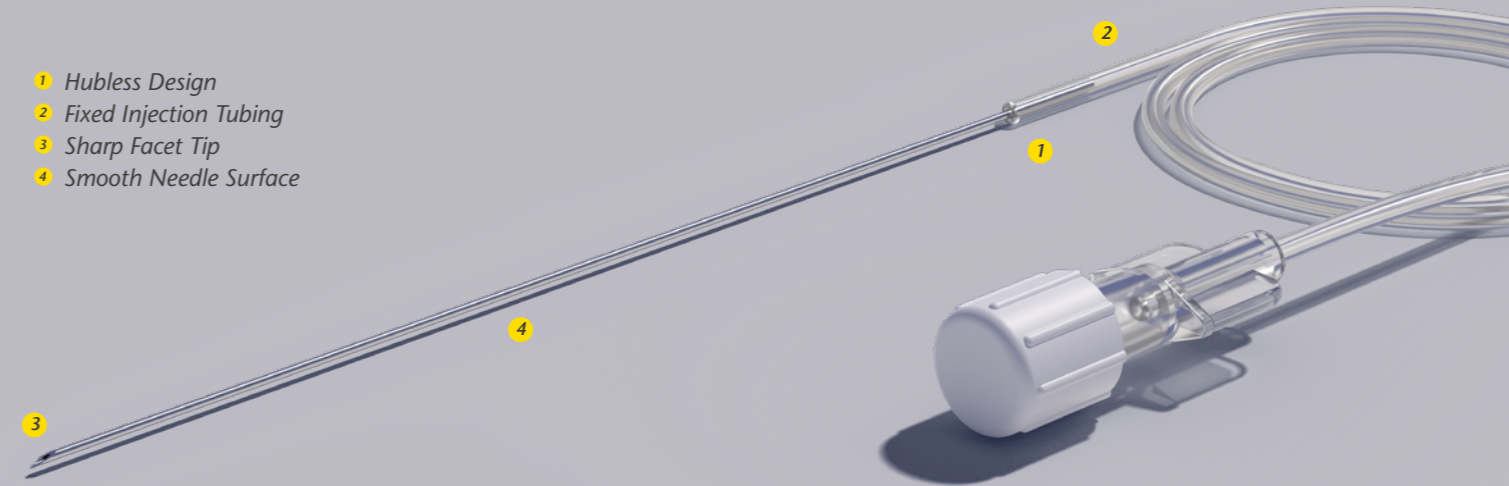

Product advantages at a glance:

- Reduced pain during puncture and needle placement
- Smooth gliding properties
- Reduced shadowing and improved visibility of target area
- Convenience due to closed system

| Description | Item no. | PU |
|----------------------|-----------|----|
| 23G x 60mm (2 1/4") | 001160-10 | 10 |
| 22G x 100mm (4") | 001160-20 | 10 |
| 21G x 120mm (4 3/4") | 001160-30 | 10 |
| 21G x 150mm (6") | 001160-40 | 10 |

EpiLong VPC & LOR Syringe



RF Ablation

Needles for RF and Pulsed RF Ablation

| Description | Item no. | PU |
|------------------------------------|------------|----|
| Plastic LOR Syringe 7ml Luer Lock | 0001151-65 | 10 |
| Plastic EpiLong VPC 10ml Luer Lock | 0001151-49 | 10 |

RFTL

Straight Thermolesion (RF) Needle with Active Tip

- 1 Straight Tip Geometry
- 2 Bevel Tip with Active Tip
- 3 Smooth Needle Coating

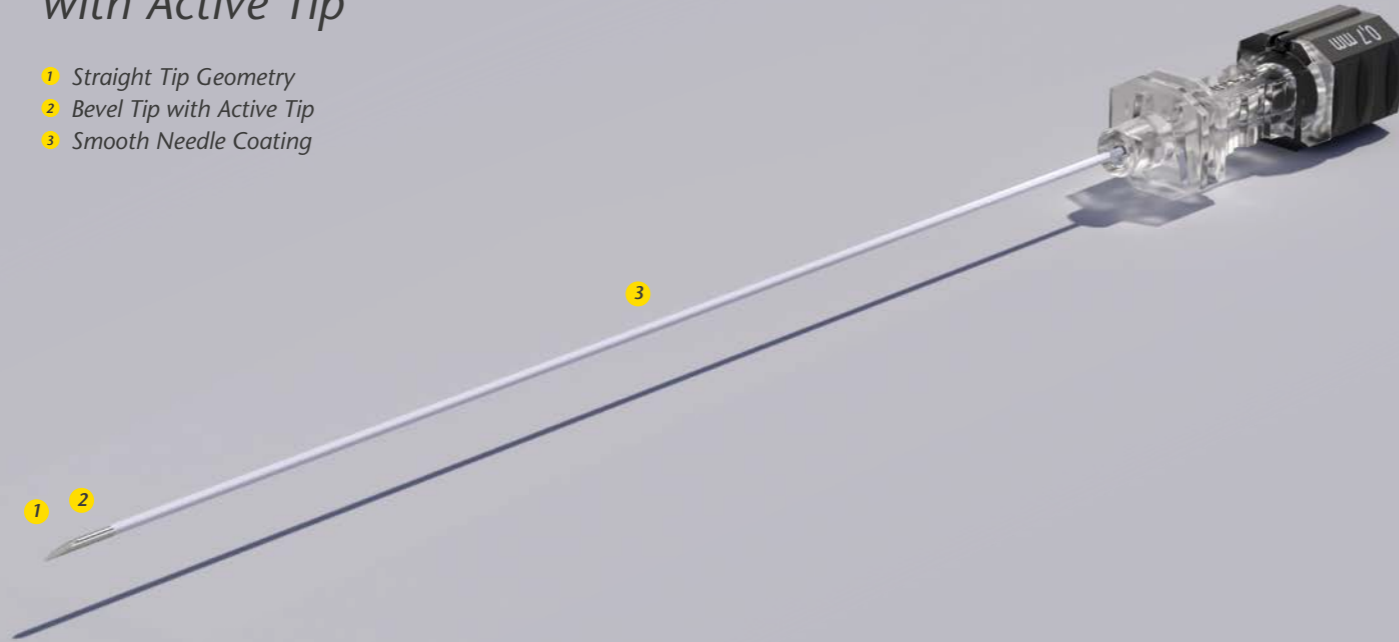

Product advantages at a glance:

- Reduced pain during puncture and needle placement
- Smooth gliding properties

| Description | Item no. | PU |
|-------------------------------------------------|------------|----|
| 22G x 52.6 mm (2") needle with 4mm Active Tip | 001165-10B | 25 |
| 22G x 98.6 mm (4") needle with 2.5mm Active Tip | 001165-20A | 25 |
| 22G x 98.6 mm (4") needle with 5mm Active Tip | 001165-20B | 25 |
| 22G x 98.6 mm (4") needle with 10mm Active Tip | 001165-20C | 25 |

| Description | Item no. | PU |
|----------------------------------------------------|-------------|----|
| 20G x 52.6 mm (2") needle with 5mm Active Tip | 001165-11D | 25 |
| 20G x 98.6 mm (4") needle with 5mm Active Tip | 001165-21B | 25 |
| 20G x 98.6 mm (4") needle with 10mm Active Tip | 001165-30D | 25 |
| 20G x 142 mm (5 1/2") needle with 2.5mm Active Tip | 001165-30A | 10 |
| 20G x 142 mm (5 1/2") needle with 5mm Active Tip | 001165-30B | 10 |
| 20G x 142 mm (5 1/2") needle with 10mm Active Tip | 001165-30C | 10 |
| 20G x 145 mm (5 3/4") needle with 5mm Active Tip | 001165-30BM | 10 |
| 20G x 145 mm (5 3/4") needle with 10mm Active Tip | 001165-30CM | 10 |
| 18G x 98.6 mm (4") needle with 10mm Active Tip | 001165-22C | 25 |

RFTL Curved

Curved Thermolesion (RF) Needle with Active Tip

- 1 Curved Tip Geometry
- 2 Bevel Tip with Active Tip
- 3 Smooth Needle Coating

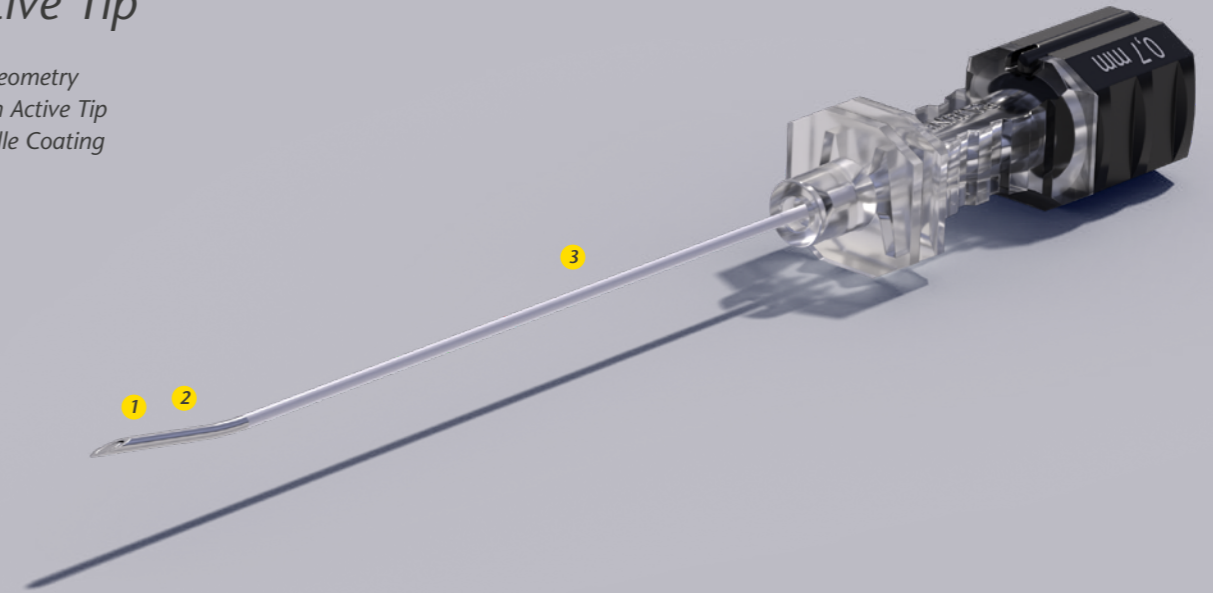

Product advantages at a glance:

- Reduced pain during puncture and needle placement
- Smooth gliding properties

| Description | Item no. | PU |
|---------------------------------------------------|-------------|----|
| 22G x 52.6 mm (2") needle with 10mm Active Tip | 011165-12C | 25 |
| 22G x 98.6 mm (4") needle with 10mm Active Tip | 011165-20C | 25 |
| 20G x 98.6 mm (4") needle with 10mm Active Tip | 011165-30D | 25 |
| 20G x 142 mm (5 1/2") needle with 10mm Active Tip | 011165-32C | 10 |
| 20G x 145 mm (5 3/4") needle with 10mm Active Tip | 011165-32CM | 10 |
| 18G x 98.6 mm (4") needle with 10mm Active Tip | 011165-40D | 25 |

RFTL Sono

Echogenic Thermolesion (RF) Needle with Active Tip

- 1 Cornerstone Reflectors
- 2 Bevel Tip with Active Tip
- 3 Smooth Needle Coating

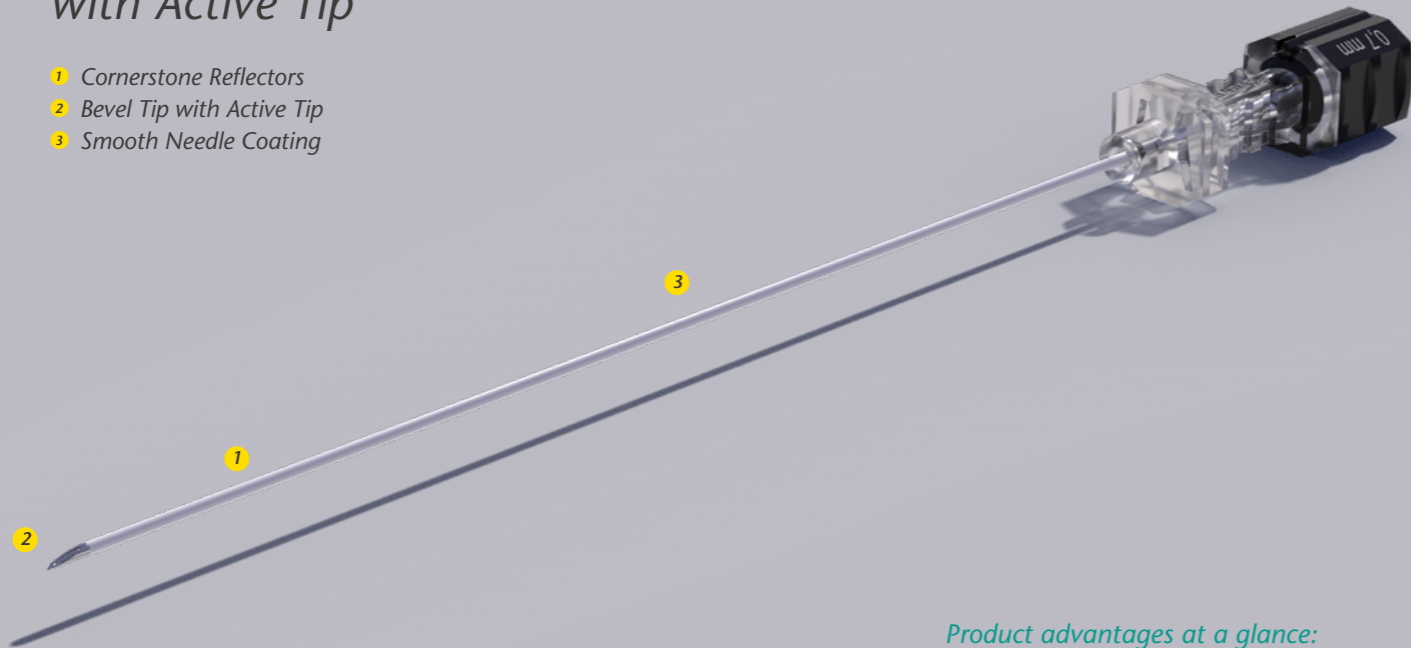

Product advantages at a glance:

- Reliable needle visualisation at any angle
- Optimised ultrasound visibility of needle shaft
- Reduced pain during puncture and needle placement
- Smooth gliding properties

| Description | Item no. | PU |
|--------------------------------------------------------|------------|----|
| 22G x 98.6 mm (4") needle with 2.5mm Active Tip | 001175-20A | 25 |
| 22G x 98.6 mm (4") needle with 5mm Active Tip | 001175-20B | 25 |
| 20G x 52.6 mm (2") needle with 5mm Active Tip | 001175-11D | 25 |
| 20G x 52.6 mm (2") needle with 10mm Active Tip | 001175-11C | 25 |

PulsedRF

Thermolesion (RF) Needle with Active Tip

- 1 Bevel Tip with Active Tip
- 2 Hubless Design
- 3 Fixed Injection Tubing
- 4 Smooth Needle Coating

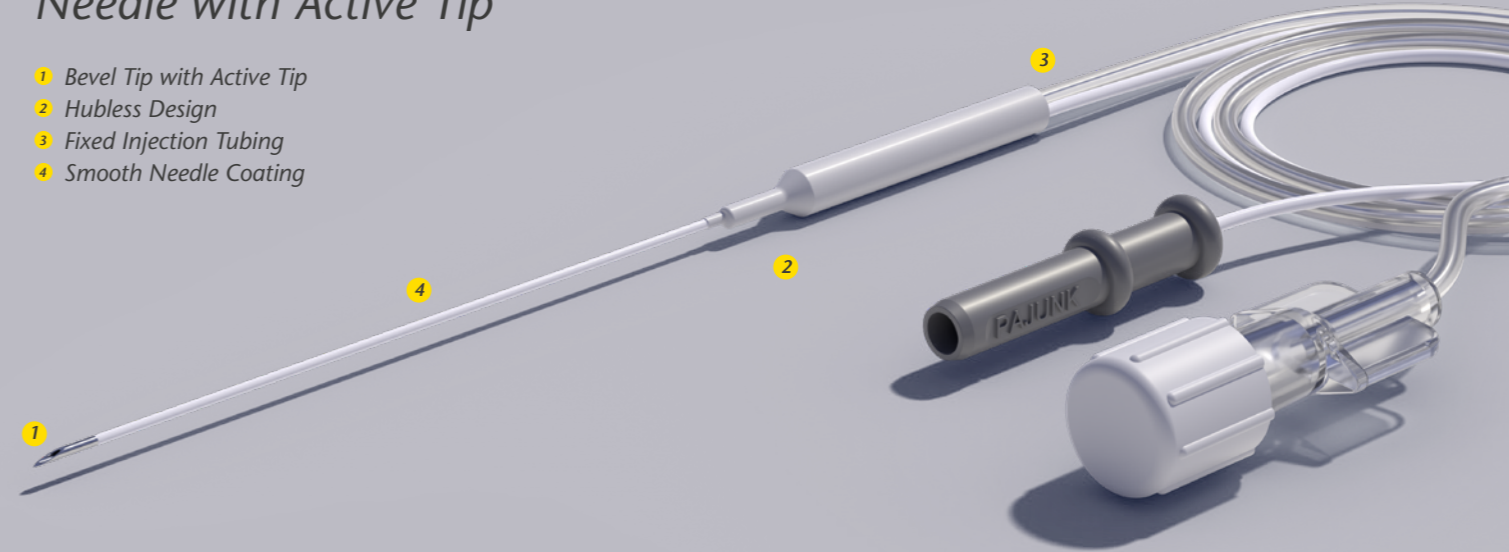

Product advantages at a glance:

- Reduced pain during puncture and needle placement
- Smooth gliding properties
- Reduced shadowing and improved visibility of target area
- Convenience due to closed system

| Description | Item no. | PU |
|---------------------------------------------------------------------------|-----------|----|
| 22G x 60 mm (2 1/4") needle with 5mm Active Tip, with Ø 1.6mm Plug | 001255-12 | 10 |
| 22G x 100 mm (4") needle with 5mm Active Tip, with Ø 1.6mm Plug | 001255-22 | 10 |
| 20G x 150 mm (6") needle with 5mm Active Tip, with Ø 1.6mm Plug | 001255-32 | 10 |

AlliClip

Alligator Clip for PulsedRF Needles



| Description | Item no. | PU |
|-----------------------------------------------------------------|------------|----|
| AlliClip Alligator Clip for PulsedRF Needles with Ø 1.6 mm Plug | 001151-39D | 10 |

Notes section with horizontal dashed lines for writing.

PAJUNK®

PAJUNK® GmbH Medizintechnologie
Global Headquarters
Karl-Hall-Straße 1
78187 Geisingen, Germany
Tel.: +49 7704 9291-0
Fax: +49 7704 9291-600
info@pajunk.com
pajunk.com

PAJUNK® Medical Produkte GmbH
Central Europe
Karl-Hall-Straße 1
78187 Geisingen, Germany
Tel.: +49 7704 8008-0
Fax: +49 7704 8008-150
info@pajunk-medipro.com
pajunk.de

PAJUNK® Medical System L.P.
United States of America
4575 Marconi Drive
Alpharetta, GA 30005, USA
Tel.: +1 888 972 5865
Fax: +1 678 514 3388
info@pajunk-usa.com
pajunkusa.com

PAJUNK® UK Medical Products Ltd
United Kingdom
Unit C1 The Waterfront
Goldcrest Way, Newburn Riverside
Newcastle upon Tyne, NE15 8NY, UK
Tel.: +44 191 264 7333
info@pajunk.co.uk
pajunk.co.uk