



SPECULUM S.A.

Acompanhamos o pulsar da vida

INSTRUMENTOS METÁLICOS ESPECIAIS!



Para **TODAS** as especialidades!



CONTACTE-NOS

808 200 306 | 214 728 040 www.speculum.pt | cliente@speculum.pt



The Tissue is Secure with...

MP™ (MARINA PARAMETRIUM) HYSTERECTOMY CLAMPS

MP™ Clamps are well-balanced and have a sturdy, atraumatic longitudinal groove that guarantees a secure grip of tissue and prevents slippage. The MP™ Hysterectomy Clamps are available in **five lengths** and five jaw configurations.

ZEPPELIN-STYLE CLAMPS

Product Description **Product No.**

Straight w/ Gold Rings

21 cm, 8.25 in.	336-411
24 cm, 9.5 in.	336-541
30 cm, 12 in.	336-601
35 cm, 14 in.	336-661
41 cm, 16 in.	336-911

Angled Shaft

21 cm, 8.5 in.	336-711
24 cm, 9.5 in.	336-741
30 cm, 12 in.	336-801
35 cm, 14 in.	336-861

Product Description **Product No.**

Slightly Curved w/ Gold Rings

21 cm, 8.25 in.	336-412
24 cm, 9.5 in.	336-542
30 cm, 12 in.	336-602
35 cm, 14 in.	336-662
41 cm, 16 in.	336-912

Angled Shaft

21 cm, 8.5 in.	336-712
24 cm, 9.5 in.	336-742
30 cm, 12 in.	336-802
35 cm, 14 in.	336-862

Product Description **Product No.**

Strongly Curved w/ Gold Rings

21 cm, 8.25 in.	336-413
24 cm, 9.5 in.	336-543
30 cm, 12 in.	336-603
35 cm, 14 in.	336-663
41 cm, 16 in.	336-913

Angled Shaft

21 cm, 8.5 in.	336-713
24 cm, 9.5 in.	336-743
30 cm, 12 in.	336-803
35 cm, 14 in.	336-863

Product Description **Product No.**

Angulated w/ Gold Rings

21 cm, 8.25 in.	336-414
24 cm, 9.5 in.	336-544
30 cm, 12 in.	336-604
35 cm, 14 in.	336-664
41 cm, 16 in.	336-914

Angled Shaft

21 cm, 8.5 in.	336-714
24 cm, 9.5 in.	336-744
30 cm, 12 in.	336-804
35 cm, 14 in.	336-864

Product Description **Product No.**

MP Vaginal Cuff Clamp

Jaw length — 50 mm	
24 cm, 9.5 in.	336-669
30 cm, 12 in.	336-670



35 cm
Angled

30 cm
Fully curved

24 cm
Slightly curved

21 cm
Straight



Latest Additions to the MP Family
MP-IFP CLAMP
 (Infundibular Pelvic Clamp)

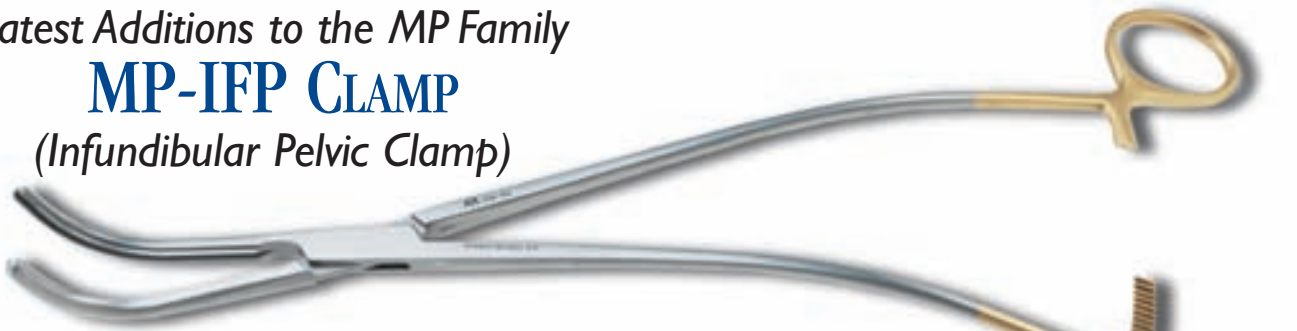

- The **Marina IFP Clamp** is perfectly shaped to reach high into the pelvis during vaginal hysterectomy salpingo-oophorectomy (BSO)
- The S-shaped shanks of the instrument are out of the way of the surgeon
- The 70 mm jaw length is able to envelop the infundibular pelvic ligament and round ligament simultaneously
- The **MP-IFP-XL Clamp** offers the extra length of two inches proximal to the box lock to accommodate the larger patient

Product Description

Product No.

MP-IFP Clamp, 11 in.

336-150

MP-IFP-XL Clamp, 13 in.

336-152



New Techniques in Vaginal Surgery Require New Surgical Instrumentation. Introducing the
KOVAC HYSTERECTOMY CLAMP



336-541K

336-542K

336-543K

When a stronger bite is what you are looking for, the **Kovac Hysterectomy Clamp** combines the gentleness of the MP Clamp with the security of the Heaney-Ballentine notches.

Product Description

Product No.

Kovac Clamp, 24 cm, 9.5 in., Straight

336-541K

Kovac Clamp, 24 cm, 9.5 in., Slight Curved

336-542K

Kovac Clamp, 24 cm, 9.5 in., Strong Curved

336-543K



All **MP™ Clamps** are available with angled shanks for greater scissoring space and clamping ability.



Classics With Quality...

HEANEY-BALLENTINE HYSTERECTOMY CLAMP



Straight/Single Curved/Single Straight/Double Curved/Double

Product Description	Product No.
21 cm, 8.25 in., Straight, Single Groove	336-376
21 cm, 8.25 in., Curved, Single Groove	336-378
21 cm, 8.25 in., Straight, Double Groove	336-380
21 cm, 8.25 in., Curved, Double Groove	336-382
25 cm, 10 in., Straight, Single Groove	336-384
25 cm, 10 in., Curved, Single Groove	336-385
25 cm, 10 in., Straight, Double Groove	336-387
25 cm, 10 in., Curved, Double Groove	336-386

Also available in 12 and 14 inch lengths

ROGERS HYSTERECTOMY CLAMP



Straight Slightly Curved Strongly Curved Angled

Product Description	Product No.
22 cm, 8.5 in., Straight	336-130
22 cm, 8.5 in., Slightly Curved	336-131
22 cm, 8.5 in., Strongly Curved	336-132
22 cm, 8.5 in., Angled	336-133

MASTERSON HYSTERECTOMY CLAMP



Straight Curved

Product Description	Product No.
22 cm, 8.5 in., Straight	336-222
22 cm, 8.5 in., Curved	336-322
25.5 cm, 10 in., Straight	336-226
25.5 cm, 10 in., Curved	336-326

HEANEY HYSTERECTOMY CLAMP



Straight/Single Curved/Single Straight/Double Curved/Double

Product Description	Product No.
21 cm, 8.25 in., Straight, Single Groove	336-340
21 cm, 8.25 in., Curved, Single Groove	336-342
21 cm, 8.2 in., Straight, Double Groove	336-370
21 cm, 8.25 in., Curved, Double Groove	336-372
30 cm, 12 in., Straight, Single Groove	336-360
30 cm, 12 in., Curved, Single Groove	336-362
30 cm, 12 in., Curved, Double Groove	336-366



More Hysterectomy Clamps...

GLENNER HYSTERECTOMY CLAMPS

Prod. Description	Length	Product No.
Curved left	8 1/4 in.	336-142
Curved right	8 1/4 in.	336-144

- Ideal in vaginal hysterectomy to grasp lower ligaments
- Curved for right and left side performance
- Longitudinal serrations provide secure grasping



M.D. ANDERSON CLAMP

- Ideal for clamping adnexal tissue during hysterectomy
- Longitudinal serrations in atraumatic jaws

Product Description	Product No.
10 in.	336-125
11 in.	336-128
14 in.	336-129



CLARK CLAMP

- Used for tunneling around ureters during pelvic surgery
- Longitudinal serrations in jaw gently grasp tissue

Product Description	Product No.
8 3/4 in.	336-021
12 in.	336-022
14 in.	336-024



NOLAN NEEDLE HOLDER

- Extended boxlock prevents torquing of shanks
- Long and extra long length for deep surgery

Product Description	Product No.
10 in.	420-865
12 in.	420-870
12 in. CVD Tip	420-871
14 in.	420-875
14 in. CVD Tip	420-876



Forceps and Needle Holders

LAHEY FORCEPS



Product Description	Product No.
Lahey Forceps, Sharp Teeth, Two prong: 20 cm / 8 in.	330-571
Lahey Forceps, Sharp Teeth, Three prong: 25 cm / 10 in.	330-572

HEANEY NEEDLE HOLDER



Product Description	Product No.
Heaney Needle Holder - Curved, TC Inserts: 21 cm / 8.25 in.	420-540
Heaney Needle Holder - Curved, TC Inserts: 26.5 cm / 10.5 in.	420-546

Vaginal Dissection Scissors

MAYO-NOBLE



Product Description	Product No.
Mayo-Noble Dissection Scissors	050-148

ZIMMERMAN-YAGI



Product Description	Product No.
Zimmerman-Yagi Dissection Scissors	050-160

METZENBAUM

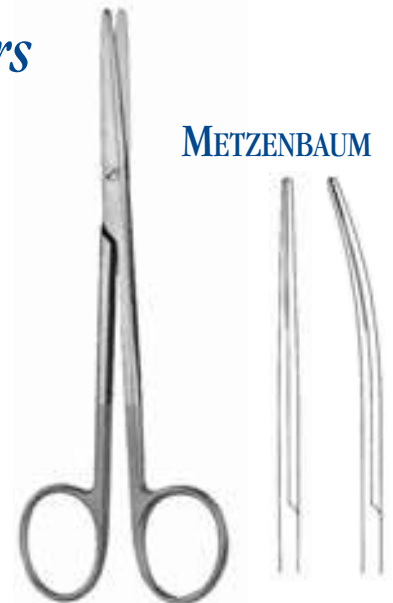

Prod. Description	Straight	Curved
11.5 cm / 4.5 in.	050-175	050-176
14.5 cm / 5.75 in.	050-179	050-180
18 cm / 7.0 in.	050-181	050-182
20 cm / 8.0 in.	050-183	050-184
23 cm / 9.0 in.	050-186	050-188



The Complete Source for Pelvic Reconstructive Surgical Instrumentation

Precision in Cutting MP™ (MARINA PARAMETRIUM) SCISSORS

MP™ Scissors are a complete set of Parametrium scissors designed to match precisely to the MP™ Hysterectomy Clamp jaw curvatures. The MP™ Scissors guarantee precise cutting. The scissors feature tungsten serrated blades to ensure tissue does not slip during cutting. The MP™ Scissors are available in four lengths and three jaw configurations.



Product Description	Product No.
Slightly Curved w/ Gold Rings	
23 cm, 9 in.	410-123
26.5 cm, 10.5 in	410-126
30 cm, 12 in.	410-130
35 cm, 14 in.	410-333



Product Description	Product No.
Strongly Curved w/ Gold Rings	
23 cm, 9 in.	410-223
26.5 cm, 10.5 in	410-226
30 cm, 12 in.	410-230



Product Description	Product No.
Angulated w/ Gold Rings	
23 cm, 9 in.	410-323
26.5 cm, 10.5 in	410-326
30 cm, 12 in.	410-330
35 cm, 14 in.	410-335
41 cm, 16 in. (Jorgensen)	410-337



**NOW AVAILABLE
IN 16 INCH
LENGTH!**



Hysterectomy Special Accessories

252-055

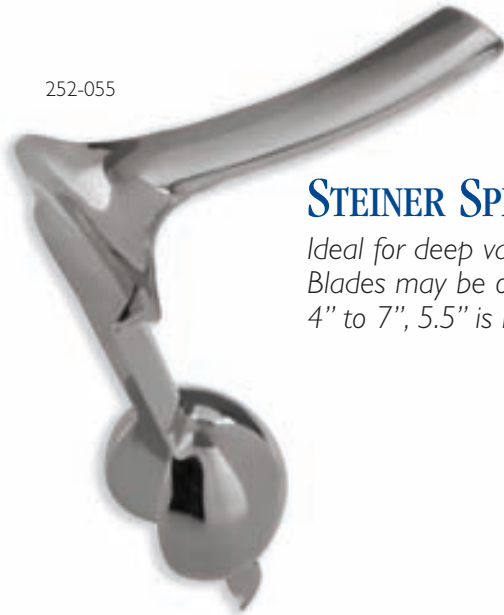

STEINER SPECULUM

Ideal for deep vaginal surgery. Blades may be ordered from 4" to 7", 5.5" is normal length.

Product Description

1.1 Kg / 2.5 lb:
14 cm x 3 cm / 5.5 in. x 1.25 in.

Product No.

252-055

252-020



HARDY-DUDDY SPECULUM

It will not fall out. Design places the 3.5 lbs weight at a right angle to the shaft of the speculum, preventing expulsion. Many blade options are available.

Product Description

Hardy-Duddy Speculum,
3.5 lbs., 120 mm x 35 mm / 5.5 in.,
cupped blade

Product No.

252-020



AUWARD SPECULUM

An assortment of weighted Auvard specula is available.

Product Description

1.1 Kg / 2.5 lb:
8.5 cm x 4 cm / 3.5 in. x 1.5 in.

Product No.

252-009

1.1 Kg / 2.5 lb:
10 cm x 4.5 cm / 4 in. x 1.75 in.

252-010

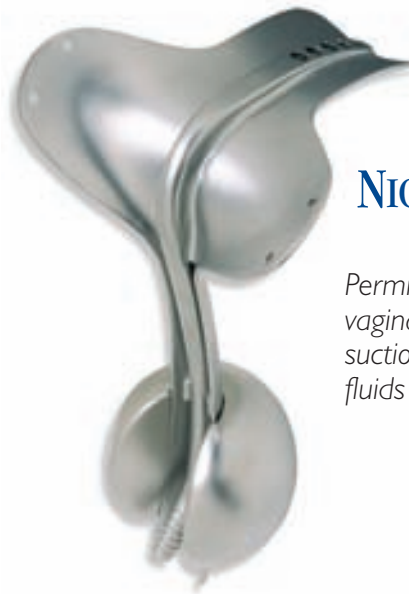

NICHOLS WEIGHTED SPECULUM

Permits retraction of posterior vaginal wall, while providing suction and measurement of fluids from the surgical site.

Product Description

Nichols Vaginal Weighted Speculum
with Suction, 2.5 lbs. 2.75 in. x 1.5 in.

Product No.

350-180



BREISKY RETRACTORS

Product Description	Product No.
100 mm x 18 mm	254-407
100 mm x 25 mm	254-410
100 mm x 30 mm	254-412
100 mm x 35 mm	254-414
100 mm x 38 mm	254-415
120 mm x 30 mm	254-512
130 mm x 35 mm	254-514
140 mm x 35 mm	254-516
150 mm x 35 mm	254-613
160 mm x 35 mm	254-615
170 mm x 25 mm	254-620
170 mm, heart-shaped	254-622

PELOSI VR RETRACTORS



- Ergonomically shaped and lightweight handle
- Perforations in the blade provide traction against the vaginal wall to prevent the retractor from slipping
- The "Z"-shape of the retractor enables the assistant to keep his hand away from the surgical field so the surgeon has optimal exposure

Product Description	Product No.
Small, 30 mm x 90 mm	254-519
Large, 35 mm x 110 mm	254-518

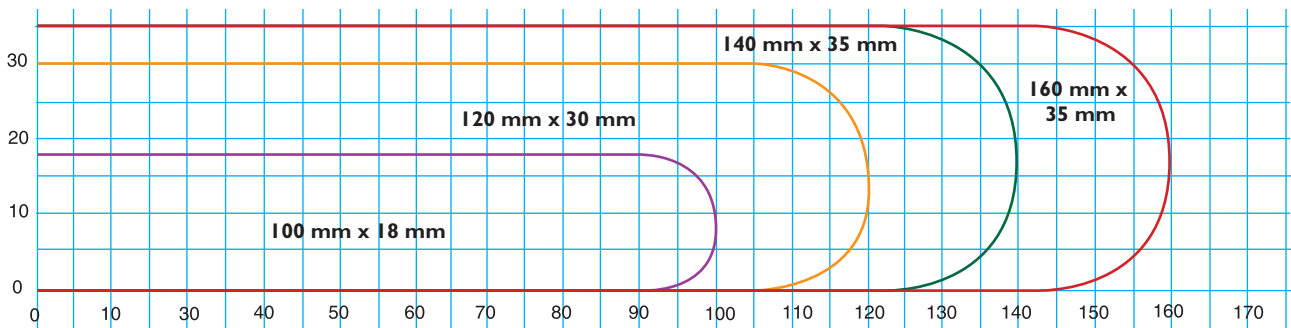

VERONIKIS VAGINAL RETRACTORS

Designed to achieve maximum visibility in the narrow vaginal operative tunnel.

Product Description	Product No.
1 in. (2.5 cm) blade width, 12 in. length	254-701
1 in. (2.5 cm) blade width, 13.5 in. length	254-701C
1.5 in. (3.8 cm) blade width, 12 in. length	254-702
1 in. (2.5 cm) Tapered blade, 12 in. length	254-704

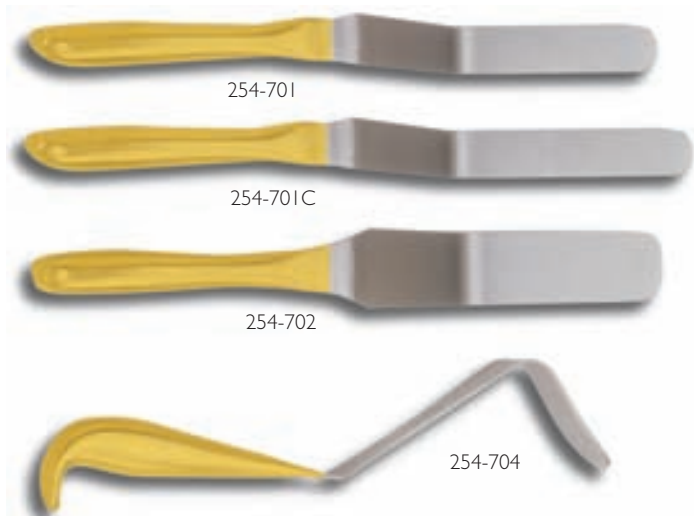



The New Wave in GYN

Diagnostic Instruments for Pelvic Disorders

POP-Q EXAM STICK

Easy to use • Cost-effective • Accurate
Ink-free disposable
wooden sticks

POPstix

The POP-Q Exam stick is the main clinical tool to identify the severity of pelvic organ prolapse and the anatomical success or failure of prolapse surgery.

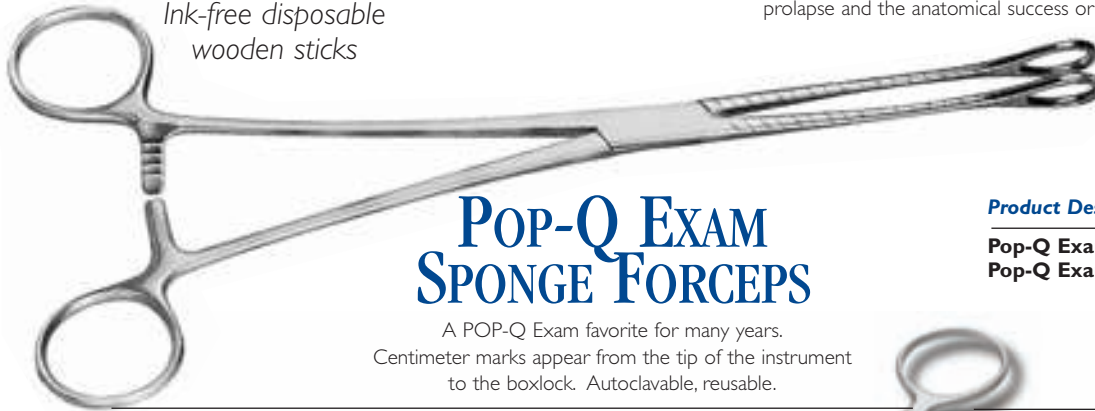

POP-Q EXAM SPONGE FORCEPS

A POP-Q Exam favorite for many years. Centimeter marks appear from the tip of the instrument to the boxlock. Autoclavable, reusable.

Product Description	Product No.
Pop-Q Exam Stick, box of 50	222-222
Pop-Q Exam Sponge Forceps	350-225

350-220

BADEN VAGINAL DEFECT ANALYZERS

For evaluation of paravaginal defects as presented by Wayne Baden, M.D.



Product Description

The **original style** as defined by Dr. Baden with 2 1/4 inch long blades, slightly angled
The **Baden-Nichols style** with 1 1/2inch, deeply angled blades, more specific to level 2 of the vagina

Product No.

350-220
350-222

MARINA MASSON FASCIALATA STRIPPER

For precise harvesting of fascialata (a short video showing technique is available upon request).



Product Description **Product No.**

Stripper, 1 cm (Inner Diameter) 350-400
Stripper, 2 cm (Inner Diameter) 350-402
Complete set of 2 350-412

WALTHER URETHRAL CATHETERS

Classic bladder filling and emptying catheter, stainless steel.



Product Description **Product No.**

12 FR 220-312
14 FR 220-314
16 FR 220-316
18 FR 220-318
20 FR 220-320
22 FR 220-322
24 FR 220-324
26 FR 220-326
28 FR 220-328
30 FR 220-330
32 FR 220-332
34 FR 220-334
Set of 12, 12- 34 220-300

Also available - Urethral Sounds



MIYAZAKI LIGHTED RETRACTORS™

Lighted Retractors That Make Sense!

A. Miyazaki All-Purpose Retractor

Useful in modified Burch procedures, sacrospinous suspension of prolapsed vault and other transvaginal procedures.

B. Miyazaki Sacropexy Retractor

Useful in sacrocolpopexy and other abdominal approach sacral procedures.

C. Marina Lighted Breisky Retractor with Light Pipe built-in

The most commonly used retractor now available with pin-point light.

D. Marina Heaney-Simon Lighted Retractor with Light Pipe built-in

The most popular anterior wall retractor with a convenient out-of-the-way fiberoptic light.

E. Marina Lighted Yankauer Suction Tube with Light Pipe built-in

At your request, the most popular suction tube in GYN surgery, now with the convenience of available light even in the darkest surgeries.

F. Marina "Triple Threat" Suction Tube with Light Pipe & Irrigation built-in

Our newest and most popular blunt dissection instrument. Combines suction, irrigation and light. Cost effective.

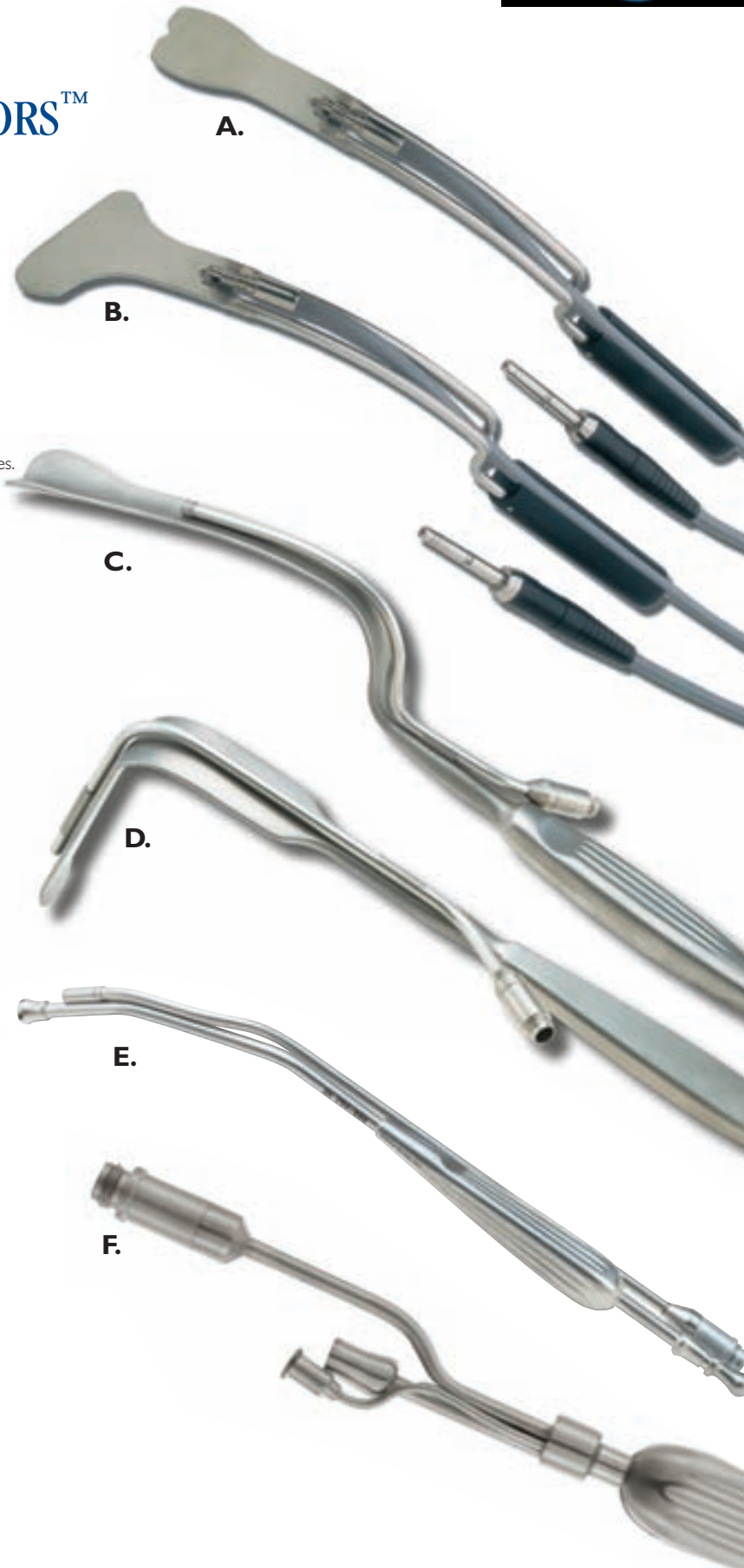

<i>Product Description</i>	<i>Product No.</i>
Miyazaki All-Purpose Retractor	254-630
Miyazaki Sacropexy Retractor	254-632
Marina Lighted Breisky Retractor	254-640
Marina Heaney-Simon Lighted Retractor	254-642
Marina Lighted Yankauer Suction Tube	254-644
Marina "Triple Threat" Yankauer Suction Tube	254-648



The Complete Source for Pelvic Reconstructive Surgical Instrumentation

Special Instruments for Pelvic Disorders

THE ZIMMERMAN MYOTOME INSTRUMENT SET

For use during vaginal delivery of myomatous uteri.

Uniquely designed myotomes help morselate and remove myoma quickly and with minimum trauma. Zimmerman Graspers hold the myoma firmly while the Zimmerman Myotomes are used to enucleate the myoma from surrounding tissue. A complimentary video (332-420) is available to show this myomectomy technique. Ask your Marina Medical Rep for a copy.



Product Description

Product No.

Zimmerman Myotome Instrument Set (4 items)	332-400
Includes Chisel Tip, Spoon Tip Myotome, Grasper, 8 mm & Grasper, 13 mm	
Zimmerman Myotome, Chisel Tip, 29 cm	332-410
Zimmerman Myotome, Spoon Tip, 24 cm	332-412
Zimmerman Myotome Grasper	332-414
3 x 3 Teeth x 8 mm wide, 25 cm / 10 in.	
Zimmerman Myotome Grasper	332-416
3 x 3 Teeth x 13 mm wide, 20 cm / 8 in.	
Martin Myomectomy Scissors Straight, Serrated, 20 cm / 8 in.	050-532
Martin Myomectomy Scissors Curved, Serrated, 20 cm / 8 in.	050-534

TRANSOBTURATOR SLING NEEDLES



Product Description

Product No.

Transobturator Sling Needle, Type I, Short, pair (L & R)	350-007
Transobturator Sling Needle, Type II, Short, pair (L & R)	350-008
Transobturator Sling Needle, Type III, Long (Anterior/Posterior)	350-009



The New Wave in GYN

Marina Medical proudly responds to the need for longer instruments during abdominal hysterectomy and related oncology procedures. Well organized and extremely complete, the surgeon has a selection from over 20 different instruments.

Custom Sizes Available



To keep your extra-long instruments neatly packaged and well organized, Marina Medical offers a custom-fitted, sterile container and basket.



Tissue Forceps

- 060-052-12"
- 060-054-14"
- 060-056-16"
- 060-057-18"



Singley Forceps

- 060-304-12"
- 060-306-14"
- 060-308-16"
- 060-309-18"



De Bakey Forceps

- 060-504-12"
- 060-506-14"
- 060-507-16"
- 060-508-18"



Kocher Forceps

- 070-303-12"
- 070-305-14"
- 070-305XL-16"



Metzenbaum Scissors

- 410-134-12"
- 410-135-14"
- 410-135XL-16"
- 410-135XXL-18"



Gemini/Mixer Forceps

- GEM070-353-12"
- GEM070-355-14"
- GEM070-355XL-16"
- MIX070-365-14"
- MIX070-365XL-16"



Sponge Forceps

- 070-650-14"
- 070-655-16"
- 070-657-16", Curved



Product Description

Sterilization container, 23 in. x 11 in. x 5.9 in.
Sterilization basket, 21.5 in. x 10 in. x 3.9 in.

Product No.

020-044
020-045

THE DEEP PELVIC TRAY

Instruments
Up To
18"



MP Parametrium Clamps -14" and 16"

- 336-661 Straight 14"
- 336-662 Slightly Curved 14"
- 336-663 Full Curved 14"
- 336-664 Angled 14"
- 336-991 Straight 16"
- 336-912 Slightly Curved 16"
- 336-913 Full Curved 16"
- 336-914 Angled 16"



Babcock Forceps

- 161-530-12"
- 161-535-14"
- 161-536-16"
- 161-537-18"



Cushing Vein Retractor

- 110-311-12"
- 110-312-14"
- 110-316-16"



MP Parametrium Scissors

- 410-333 Slightly Curved
- 410-335 Full Curved, 14"
- 410-337 Full Curved, 16"



Heaney Needle Holder

- 420-548-12"
- 420-550-14"
- 420-552-16"



Allis Forceps

- 160-335-12"
- 160-340-14"
- 160-342-16"
- 160-344-18"

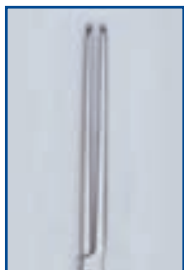

Rochester Pean Forceps

- 070-313-12"
- 070-315-14"
- 070-315XL-16"



Yankauer Suction

- 190-620-14"
- 190-622-16"
- 190-624-18"



MD Anderson Forceps

- 336-128-11"
- 336-129-14"
- 336-129XL-16"



Masson Needle Holder

- 420-435-14"
- 420-437-16"



Nolan Needle Holder

- 420-870-12"
- 420-875-14"
- 420-877-16"
- 420-878XXL-18"



Clark Artery Forceps

- 336-022-12"
- 336-024-14"
- 336-026-16"



MINOR SURGERY SETS

Marina Medical offers a wide range of instruments used in minor surgeries performed in the office or hospital. Below are pictured the most popular items. (If you do not see your favorite item, please ask your rep for it.)



040-070

**#3
GRADUATED
HANDLE**

For blades #10-18
13.0 cm / 5.0 in.



040-090

**#7
HANDLE**

For blades #10-18
16.0 cm / 6.2 5in.



ADSON FORCEPS

Without teeth

Product Description	Product No.
Straight, Fine - 1.5 mm Tip - 12 cm / 4.75 in.	060-117
Standard - 2 mm Tip - 12 cm / 4.75 in.	060-120
Fenestrated Handle - 2 mm Tip - 12 cm / 4.75 in.	060-121
Straight - 2 mm Tip - 15 cm / 6 in.	060-125

With teeth

Product Description	Product No.
1 x 2 Teeth, Straight - 2 mm Tip - 12 cm / 4.75 in.	060-130
1 x 2 Teeth, Fenestrated Handle - 2 mm Tip - 12 cm / 4.75 in.	060-131
1 x 2 Teeth - 2 mm Tip - 15 cm / 6 in.	060-132
1 x 2 Teeth, Straight, Fine , 1.5 mm Tip - 12 cm / 4.75 in.	060-134
1 x 2 Teeth, Curved - 2 mm Tip - 12 cm / 4.75in	060-140
2 x 3 Teeth, Straight - 2 mm Smooth Tip - 12 cm / 4.75in.	060-150

MAYO-HEGAR NEEDLE HOLDERS

Prod. Description	Product No.
Stainless Steel	
15 cm / 6.0 in.	080-140
18 cm / 7.0 in.	080-160
20 cm / 8.0 in.	080-180
23 cm / 9.0 in.	080-200
26.5 cm / 10.5 in.	080-220
TC-Smooth	
18 cm / 7.0 in.	420-317
TC-Serrated	
14 cm / 5.5 in.	420-314
16 cm / 6.25 in.	420-316
18 cm / 7.0 in.	420-318
20 cm / 8.0 in.	420-320
23 cm / 9.0 in.	420-323
26.5 cm / 10.5 in.	420-326



Marina Cervical and Uterine Instruments

COHEN MARINA CANNULA / MANIPULATOR

- Comes complete with one small and one large cervical cone

Manipulator with Adapters	Replacement Small Cone	Replacement Large Cone
791-161	Z0000126450	Z0000126451





REUSABLE OS FINDER SET

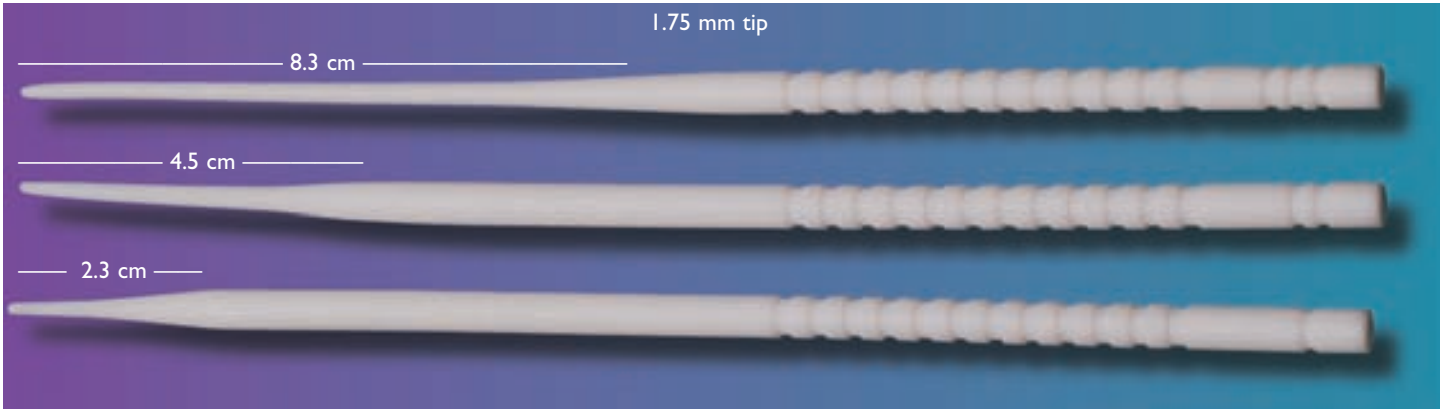

- Excellent for treatment of post menopausal patients with stenosis
- Excellent for endometrial or hysteroscopic procedures
- Gentle and forgiving during cervical canal dilation

Product No. 260-600

Fundus Finder, 8.5 in. Product No. 260-601

Opens the internal OS and sounds the fundus.

OS Finder, 8.5 in. 260-602

Finds and opens the external OS by tracking the narrow end against the cervix.

Canal Finder, 8.5 in. Product No. 260-603

Gently dilates the natural path of the cervical canal.



- Packed individually, sterile
- Convenient for immediate use
- 8.5 in.

DISPOSABLE CANAL FINDER



Product Description

Disposable Canal Finder, 8.5 in.
Sterile, box of 50

Product No.

260-610

(6 each at no charge in every box of endometrial samplers.
To order, see page 33)

NEW 4-BLADED VAGINAL SPECULUM



Stainless Steel



- One instrument... four blades
- No need to combine instruments
- Available in stainless steel or coated

Product Description

4-Sided Speculum, Pederson, Medium
4-Sided Speculum, Pederson, Large

Product No.

250-625
250-626



Non-Conductive Coating

Product Description

4-Sided N/C Speculum, Pederson, Medium
4-Sided N/C Speculum, Pederson, Large

Product No.

310-608
310-609



MARINA VAGINAL SPECULA

CLINTON Extra-Long Vaginal Speculum

Product Description *Blade Size* *Product No.*

GRAVES

Small	3 in. x .75 in.	250-301
Medium	4 in. x 1.5 in.	250-302
Large	4.75 in. x 1.5 in.	250-303
Clinton Graves Style	6 in. x 1.5 in.	250-602
Vu-Mar Graves, Small	3.5 in. x 1 in.	250-400
Vu-Mar Graves, Medium	4 in. x 1.5 in.	250-401
Vu-Mar Graves, Large	4.75 in. x 1.5 in.	250-402
XL Graves, Medium	4 in. x 1.5 in.	250-403
XL Graves, Large	4.75 in. x 1.5 in.	250-404
XXL Graves Style	7 in. x 1.75 in.	250-605

PEDERSON

Virginal	3 in. x .5 in.	250-501
Medium	4 in. x 7/8 in.	250-502
Large	4.5 in. x 1 in.	250-503
X-Narrow	4.5 in. x .5 in.	250-504
Clinton Pederson Style	6 in. x 1 in.	250-603
XL Pederson, Medium	4 in. x 1 in.	250-413
XL Pederson, Large	4.5 in. x 1 in.	250-414

MOORE-GRAVES

Medium	3.25 in. x 1.5 in.	250-306
--------	--------------------	---------

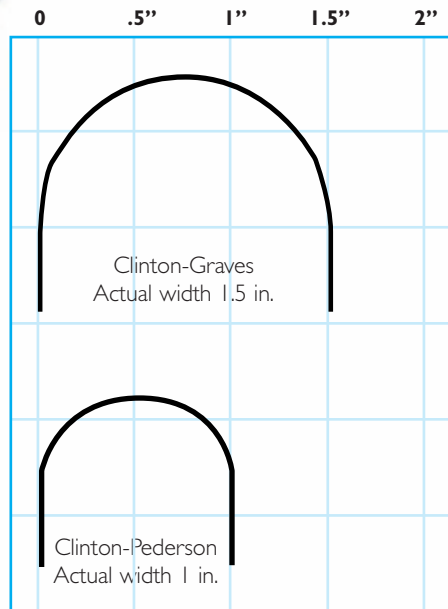
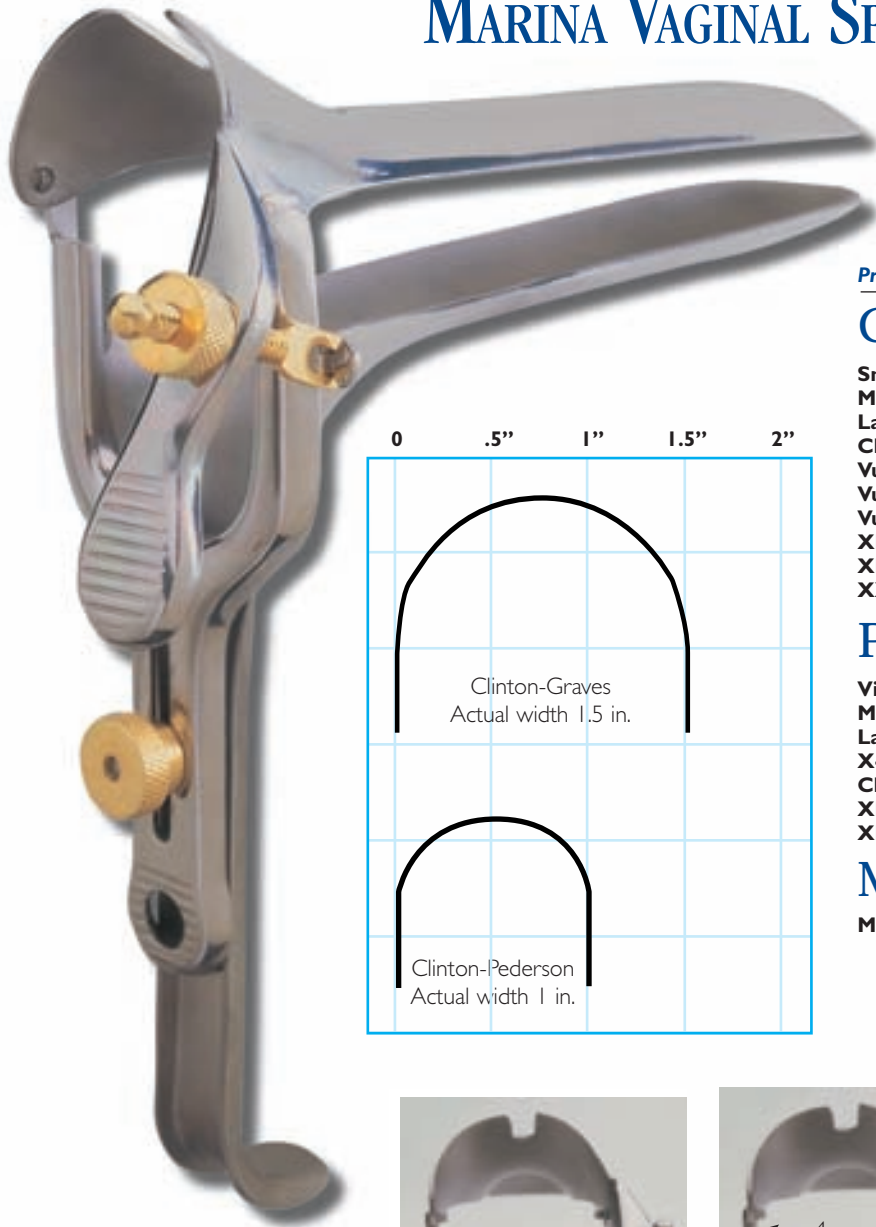

Normal, Wide & Wider

- Vu-Mar specula help visibility and instrument maneuvering
- Allow greater access at proximal end of speculum without decreasing patient comfort



Vu-Mar XL features four choices of blades.



Weisman-Pederson

Weisman-Graves

Open-Sided MARINA WEISMAN SPECULA

- The open-sided specula with the narrow Pederson blade — allows easy entrance and exit of auxiliary instruments
- Ideal for nulliparous or menopausal patients
- Extra-narrow blades available on request

Weisman Open-Sided

Product Dimension	Product No.
Graves, Large, Left, 4.75 in. x 1.5 in.	250-101
Graves, Medium, Left, 4 in. x 1.5 in.	250-102
Graves, Large, Right, 4.75 in. x 1.5 in.	250-103
Graves, Medium, Right, 4 in. x 1.5 in.	250-104
Clinton-Graves, Right Open, 6 in. x 1.5 in.	250-604
Clinton-Graves, Left Open, 6 in. x 1.5 in.	250-606
Clinton-Pederson Right Open, 6 in. x 1 in.	250-609
Pederson, Narrow, Right Open, 4 in. x 1 in.	250-111
Weisman-Graves, Left Open, XXL, 7 in.	250-607
Weisman-Graves, Right Open, XXL, 7 in.	250-608

MARINA SIDE WALL RETRACTORS

- For redundant vaginal wall retraction
 - Major selection of style and blade length
 - All German stainless steel

LATERAL WALL RETRACTORS (OPEN SHANKS)

(Use inside Graves or Pederson Speculum)

Product Description	Product No.
Open Shanks, 2.5 in. blades	250-610
Open Shanks, 3.5 in. blades	250-612
Open Shanks, 4.5 in. blades	250-614



250-610

LATERAL WALL RETRACTORS (CLOSED SHANKS)

(Use inside Graves or Pederson Speculum)

Product Description	Product No.
Closed Shanks, 2.5 in. blades	250-611



250-619



250-611

REDUNDANT WALL RETRACTOR

(Use outside Graves or Pederson Speculum)

Product Description	Product No.
Rigby Blades, 3.5 in.	250-619
Rigby Blades, 5 in.	250-620



MORE DILATOR SETS

HEGAR DILATORS

Single Ended

Size	Product No.
1 mm	260-151
1.5 mm	260-152
2 mm	260-153
2.5 mm	260-154
3 mm	260-155
3.5 mm	260-156
4 mm	260-157
4.5 mm	260-158
5 mm	260-159
5.5 mm	260-160
6 mm	260-161
6.5 mm	260-162
7 mm	260-163
7.5 mm	260-164
8 mm	260-165
8.5 mm	260-166
9 mm	260-167
9.5 mm	260-168

Set of 11, 1-6 mm,
5 mm intervals
260-150

HEGAR DILATORS

Double Ended

Size	Product No.
1/2 mm: 19 cm / 7 1/2 in.	260-101
3/4 mm: 19 cm / 7 1/2 in.	260-103
5/6 mm: 19 cm / 7 1/2 in.	260-105
7/8 mm: 19 cm / 7 1/2 in.	260-107
9/10 mm: 19 cm / 7 1/2 in.	260-109
11/12 mm: 19 cm / 7 1/2 in.	260-111
13/14 mm: 19 cm / 7 1/2 in.	260-113
15/16 mm: 19 cm / 7 1/2 in.	260-115
17/18 mm: 19 cm / 7 1/2 in.	260-117
19/20 mm: 19 cm / 7 1/2 in.	260-119
21/22 mm: 19 cm / 7 1/2 in.	260-121
23/24 mm: 19 cm / 7 1/2 in.	260-123
25/26 mm: 19 cm / 7 1/2 in.	260-125

Set of 8, 3/4 mm - 17/18 mm
260-100

PRATT DILATORS

Double Ended

Size	Product No.
13/15 Fr., 29 cm / 11 1/2 in.	260-313
17/19 Fr., 29 cm / 11 1/2 in.	260-317
21/23 Fr., 29 cm / 11 1/2 in.	260-321
25/27 Fr., 29 cm / 11 1/2 in.	260-325
29/31 Fr., 29 cm / 11 1/2 in.	260-329
33/35 Fr., 29 cm / 11 1/2 in.	260-333
37/39 Fr., 29 cm / 11 1/2 in.	260-337
41/43 Fr., 29 cm / 11 1/2 in.	260-341
45/47 Fr., 29 cm / 11 1/2 in.	260-345
49/51 Fr., 29 cm / 11 1/2 in.	260-349
53/55 Fr., 29 cm / 11 1/2 in.	260-353
57/59 Fr., 29 cm / 11 1/2 in.	260-357
61/63 Fr., 29 cm / 11 1/2 in.	260-361
65/67 Fr., 29 cm / 11 1/2 in.	260-362
69/71 Fr., 29 cm / 11 1/2 in.	260-363
73/75 Fr., 29 cm / 11 1/2 in.	260-364
77/79 Fr., 29 cm / 11 1/2 in.	260-365

Set of 8, 13/15 - 41/43 Fr.
260-300

HANK DILATORS

Double Ended

Size	Product No.
5 / 6 fr / 26 cm / 10 1/4 in.	260-205
7 / 8 fr / 26 cm / 10 1/4 in.	260-207
9 / 10 fr / 26 cm / 10 1/4 in.	260-209
11 / 12 fr / 26 cm / 10 1/4 in.	260-211
13 / 14 fr / 26 cm / 10 1/4 in.	260-213
15 / 16 fr / 26 cm / 10 1/4 in.	260-215
17 / 18 fr / 26 cm / 10 1/4 in.	260-217
19 / 20 fr / 26 cm / 10 1/4 in.	260-219
21 / 22 fr / 26 cm / 10 1/4 in.	260-221
23 / 24 fr / 26 cm / 10 1/4 in.	260-223
25 / 26 fr / 26 cm / 10 1/4 in.	260-225
27 / 28 fr / 26 cm / 10 1/4 in.	260-227
29 / 30 fr / 26 cm / 10 1/4 in.	260-229

Set of 6,
9 fr - 20 fr
260-200

MINI CERVICAL DILATOR SET

Set includes:
Handle and Dilators, 1 mm - 3 mm,
Half sizes, custom pouch
260-020



The New Wave in GYN

MARINA BIOPSY PUNCHES

Produced with the highest quality German stainless steel to Marina specifications. A selection of the most popular Biopsy Punch Tips.

Standard Style

Roto-Fit Rotatable Style

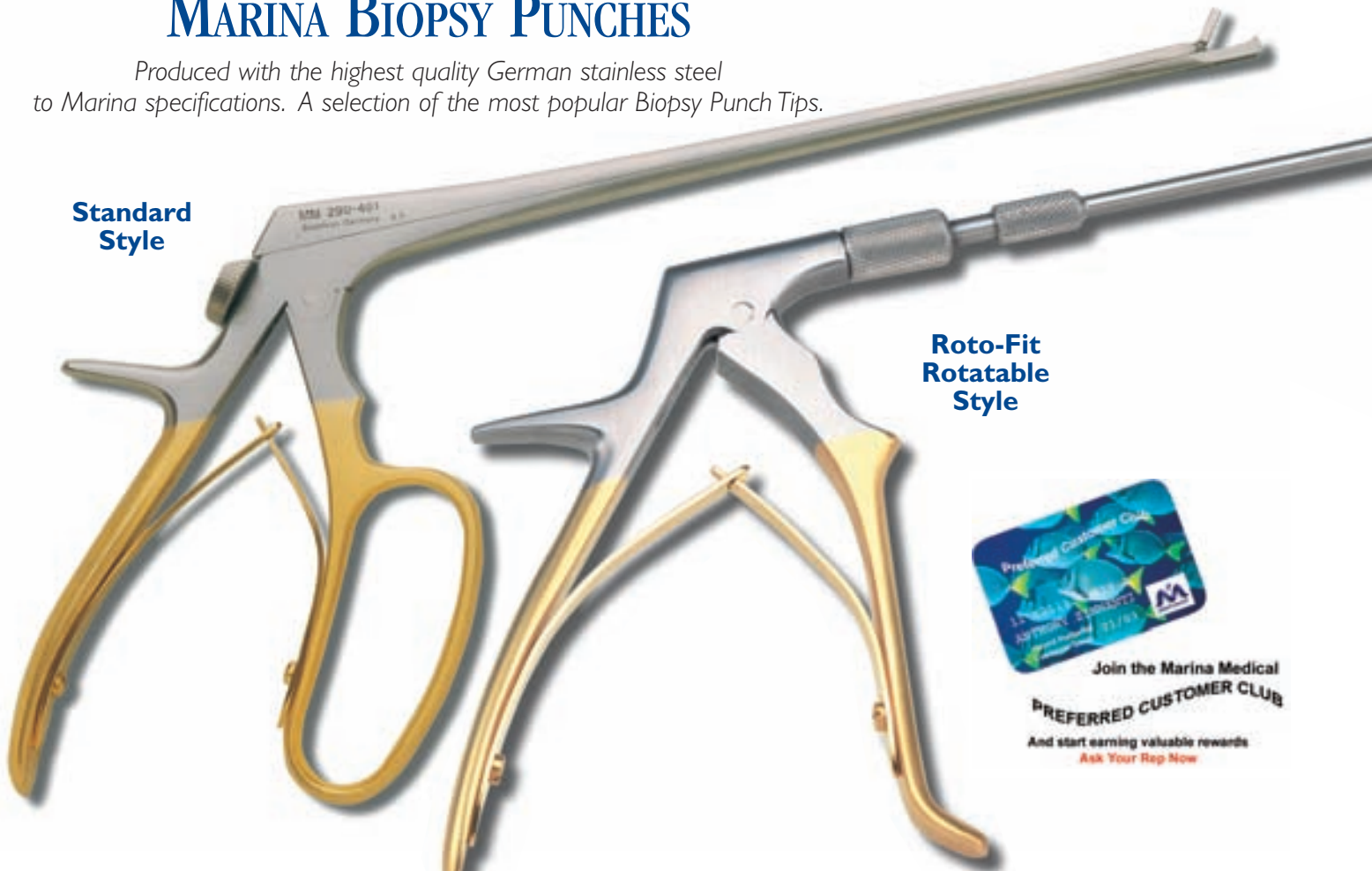

Join the Marina Medical
PREFERRED CUSTOMER CLUB
And start earning valuable rewards
Ask Your Rep Now



Tischler

Product Description	Product No.
8 in. Shaft	290-208
10 in. Shaft	290-210
11 in. Roto Fit Shaft	290-212



Baby Tischler

Product Description	Product No.
8 in. Shaft	290-308
10 in. Shaft	290-310
11 in. Roto Fit Shaft	290-312

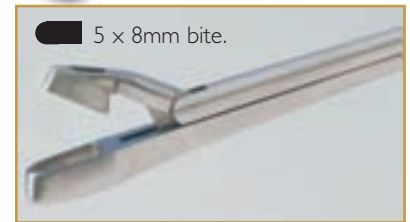

Eppendorfer

Product Description	Product No.
9 in. Shaft	290-509
11 in. Roto Fit Shaft	290-512



Burke Style

Product Description	Product No.
8 in. Open Spring Handle	290-101



Kevorkian

Product Description	Product No.
8 in. Shaft	290-401
10 in. Shaft	290-402
11 in. Roto Fit Shaft	290-404



Wittner

Product Description	Product No.
9 in., Straight	290-601
9 in., Curved	290-602



Colposcopy Instruments

KOGAN ENDOCERVICAL SPECULA **Choice!**

Endocervical specula with narrow or standard blades.
Ratchet or screw-lock mechanism available.



**Set Screw-Lock
Mechanism**

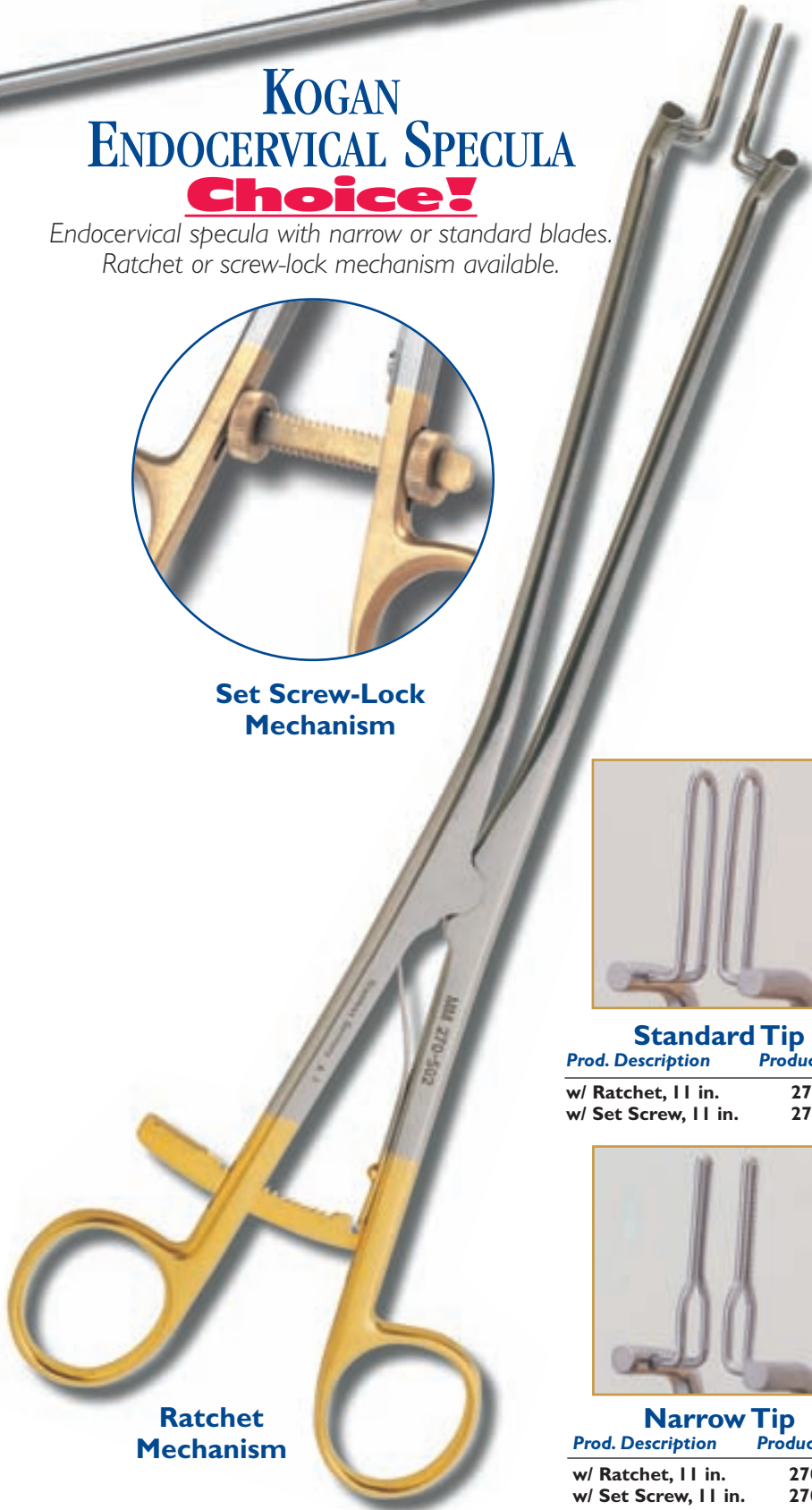

**Ratchet
Mechanism**



Standard Tip

Prod. Description	Product No.
w/ Ratchet, 11 in.	270-501
w/ Set Screw, 11 in.	270-509



Narrow Tip

Prod. Description	Product No.
w/ Ratchet, 11 in.	270-502
w/ Set Screw, 11 in.	270-512

MARINA ENDOCERVICAL CURETTES

A wide variety of endocervical
curettes with malleable or
rigid shaft.



Kevorkian Curette w/ Basket

Prod. Description	Product No.
11 3/4 in., Rigid	280-501
11 3/4 in., Malleable	280-504



Kevorkian Curette w/o Basket

Prod. Description	Product No.
11 3/4 in., Rigid	280-502
Mini Style, Rigid	280-503
11 3/4 in., Malleable	280-505



Heaney Curette

Prod. Description	Product No.
9 1/2 in., Malleable	280-401
9 1/2 in., Malleable w/ Basket	280-403



MARINA MYOMA GRASPING FORCEPS

For transcervical management of polyps and pedunculated myoma.

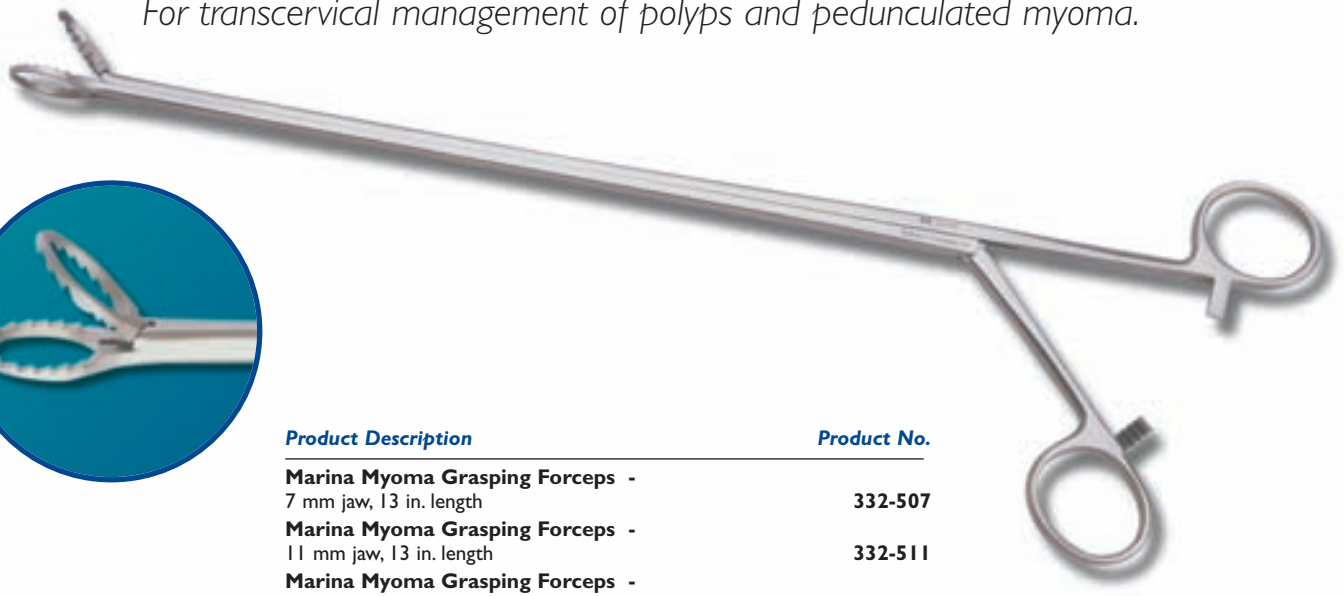

<i>Product Description</i>	<i>Product No.</i>
Marina Myoma Grasping Forceps - 7 mm jaw, 13 in. length	332-507
Marina Myoma Grasping Forceps - 11 mm jaw, 13 in. length	332-511
Marina Myoma Grasping Forceps - 17 mm jaw, 13 in. length	332-517

MARINA CERVICAL HOOKS

A wide variety of tip configurations including Emmet and Iris styles.

Emmet Hook

<i>Prod. Description</i>	<i>Product No.</i>
Full curve	295-201
Right angle	295-203
Double angle	295-205



Iris Hook

<i>Prod. Description</i>	<i>Product No.</i>
9.75 in. shaft	295-101

NEEDLE EXTENSIONS

- Convenient for cervical block. Use short needles only with small gauge to reduce bleeding
- Autoclavable, reusable

<i>Prod. Description</i>	<i>Product No.</i>
3 in.	337-003
4 in.	337-004
5 in.	337-005
6 in.	337-006





The New Wave in GYN

MARINA ENDOMETRIAL CURETTES



060-300
Singley
Cervical Forceps

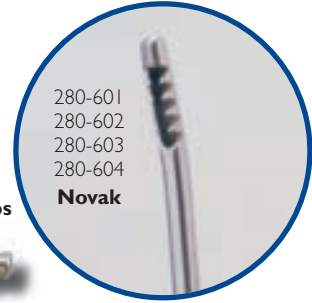

280-601
280-602
280-603
280-604
Novak

280-601 to 280-604
Novak Curette
1, 2, 3, and 4 mm

Product Description	Length	Product No.
Singley Cervical Forceps	10 in.	060-300
Novak Curette, 1 mm	9.25 in.	280-601
Novak Curette, 2 mm	9.25 in.	280-602
Novak Curette, 3 mm	9.25 in.	280-603
Novak Curette, 4 mm	9.25 in.	280-604

MARINA UTERINE CURETTES AND DILATOR/SOUNDS

Sharp or Blunt Uterine Curettes with malleable stainless steel shafts. Uterine Sounds silver-plated or stainless steel graduated in centimeters.



280-200
Sims Curette



270-302
Sims Dilator Sound

SIMS CURETTES

Sharp, Malleable, 11 in.

Size	Product No.
#00, 5 mm	280-200
#0, 6 mm	280-210
#1, 7 mm	280-211
#2, 8 mm	280-212
#3, 9 mm	280-213
#4, 11 mm	280-214
#5, 12 mm	280-215
#6, 14 mm	280-216

THOMAS CURETTES

Blunt, Malleable, 11 in.

Size	Product No.
#1, 10 mm	280-311
#2, 11 mm	280-312
#3, 12 mm	280-313
#4, 13 mm	280-314
#5, 14 mm	280-315
#6, 15 mm	280-316

Sims Dilator/Sound, 12.5 in.

Product Description	Product No.
Malleable, Silver-Plated, in centimeters	270-302
Malleable, Stainless Steel, in centimeters	270-303



330-325

330-218
Schroeder

MARINA CERVICAL TENACULA & FORCEPS

Stainless steel, German made Schroeder or Braun Tenacula with custom or ultra-delicate tips.



070-600



330-325
Braun



160-330
Atraumatic
Jaws

Product Description	Product No.
Schroeder Tenaculum, 10 in.	330-218
Braun Tenaculum, 10 in.	330-325
Atraumatic Tenaculum, 10 in.	160-330
Foerster Sponge Forceps, 10 in.	070-600



The Complete Source for Pelvic Reconstructive Surgical Instrumentation

MARINA IUD HOOKS & POLYP FORCEPS

Marina offers a selection of Specialty hooks and forceps designed for minimal patient trauma.



280-820
Double IUD
Extractor

280-801
Simple
IUD Hook



332-224

Flat Jaws



161-540

Flat Jaws



332-325

Cupped Jaws



332-224
Javerts
Forceps



161-540
Randall
Cervical
Forceps



332-325
Desjardin
Forceps

Product Description	Product No.
Simple IUD Hook, 10 in. length	280-801
Double IUD Extractor, 10.5 in.	280-820

Product Description	Product No.
Javerts Forceps, 9.5 in. length	332-224
Randall Cervical Forceps (flat jaws), 9 in. length	161-540
Desjardin Forceps (cupped jaws), 9.25 in. length	332-325

Gold-plated handles identify tungsten carbide inserts.

Spring resistant ratchet feels secure in your hand.

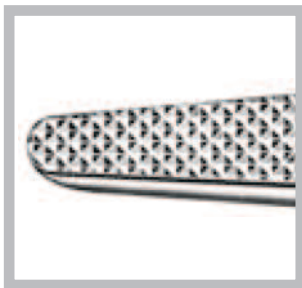

0.5mm

Designed for suture 3/0 and larger.

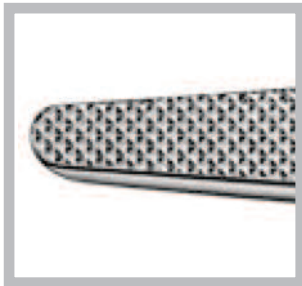



0.4mm

Designed for suture 4/0 to 6/0.

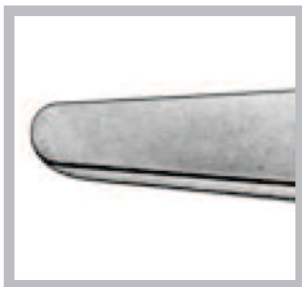

0.2mm

Designed for suture 7/0 to 10/0.



Designed for the smallest suture sizes.

NEEDLE HOLDERS

BABY WEBSTER • WEBSTER



- 420-040** Baby Webster Needle Holder, Serrated, TC, 12cm
- 420-042** Baby Webster Needle Holder, Smooth, TC, 12cm
- 420-060** Webster Needle Holder, Serrated, TC, 13cm
- 420-070** Webster Needle Holder, Smooth, TC, 13cm

Baby Webster

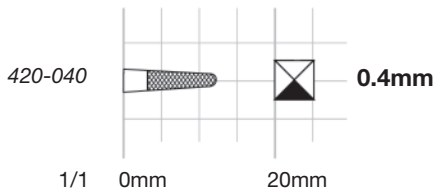

Webster

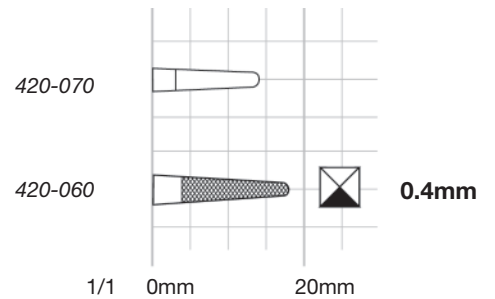

CRILE-WOOD



- 420-100** Crile-Wood Needle Holder, Serrated, TC, 15cm
- 420-100S** Crile-Wood Needle Holder, Smooth, TC, 15cm
- 420-118** Crile-Wood Needle Holder, Serrated, TC, 18cm
- 420-120** Crile-Wood Needle Holder, Serrated, TC, 20cm
- 420-123** Crile-Wood Needle Holder, Serrated, TC, 23cm

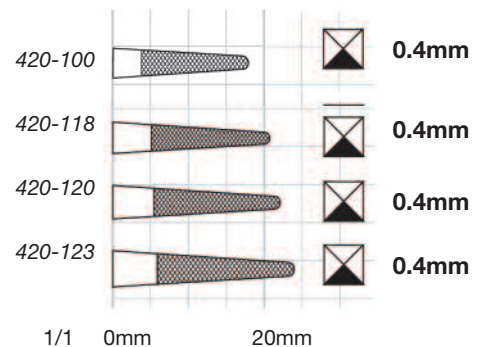



420-075 Halsey Needle Holder, Serrated, TC, 13cm
420-080 Halsey Needle Holder, Smooth, TC, 13cm

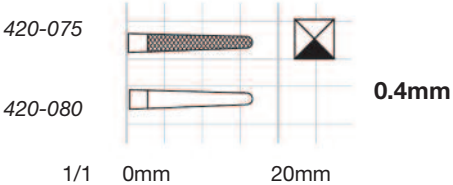

NEEDLE HOLDERS

OLSEN-HEGAR



- 420-912** Olsen-Hegar Needle Holder, Serrated, TC, 12cm
- 420-913** Olsen-Hegar Needle Holder, Smooth, TC, 12cm
- 420-914** Olsen-Hegar Needle Holder, Serrated, TC, 14cm
- 420-917** Olsen-Hegar Needle Holder, Serrated, TC, 17cm
- 420-918** Olsen-Hegar Needle Holder, Serrated, TC, 19cm

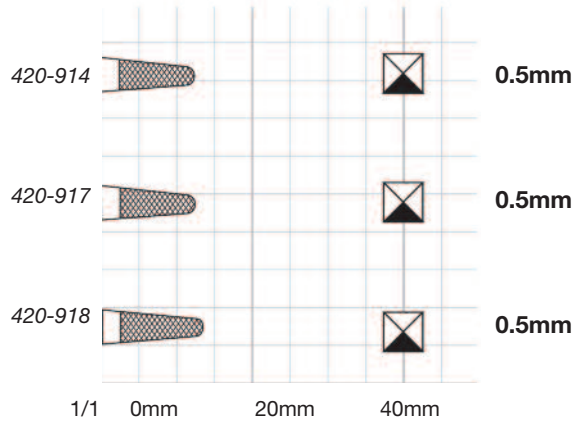

BAUMGARTNER



- 420-090** Baumgartner Needle Holder, Serrated, TC, 14cm

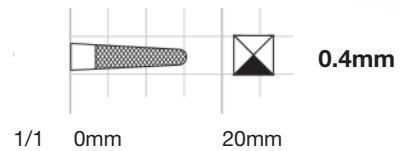

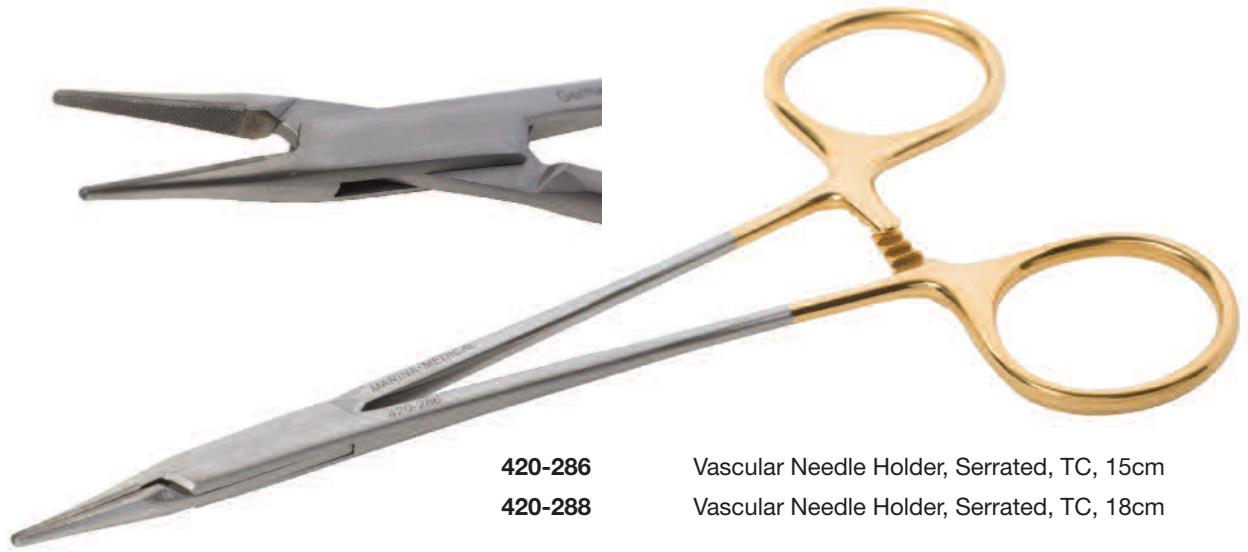

420-286
420-288

Vascular Needle Holder, Serrated, TC, 15cm
Vascular Needle Holder, Serrated, TC, 18cm

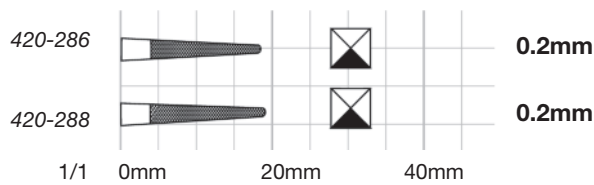

RYDER

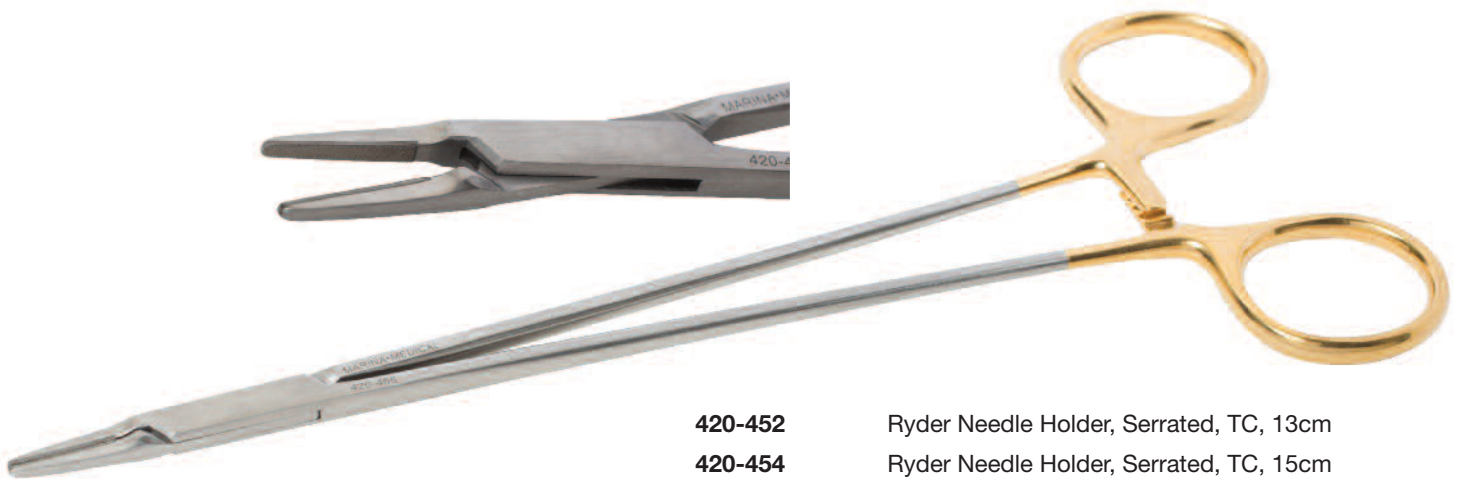

420-452
420-454
420-456
420-465
420-466

Ryder Needle Holder, Serrated, TC, 13cm
Ryder Needle Holder, Serrated, TC, 15cm
Ryder Needle Holder, Serrated, TC, 18cm
Ryder Needle Holder, Serrated, TC, 20cm
Ryder Needle Holder, Serrated, TC, 23cm

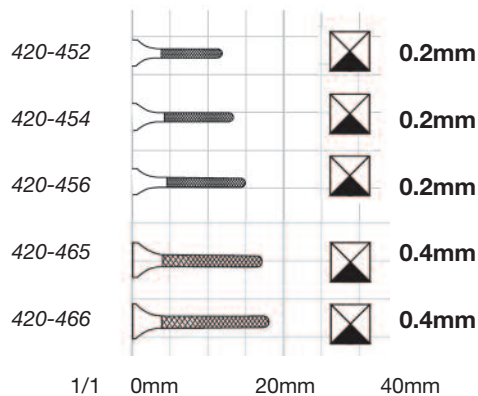

NEEDLE HOLDERS

GILLIES



420-213 Gillies Needle Holder With Scissors, Serrated, TC,

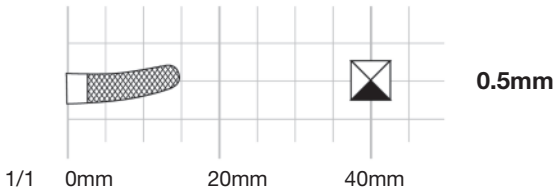

NEIVERT



420-216 Neivert Needle Holder, Serrated, TC, 13cm

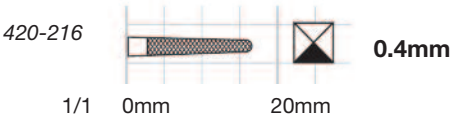



CERAMIC (GER)

- Ceramic Coating, Gold Screw
- Atraumatic Micro-Serrations
- Ceramic Coated Knife Edge and Micro-Serrations
- Fine, Precise, Minimal Trauma
- Micro-Smooth, Non-Reflective Surface
- Smooth Finger Rings
- Balanced Weight
- Lifetime Warranty*



SUPERCUT (SC)

- Black Rings, Black Screw
- Atraumatic Micro-Serrations
- Knife Edge and Micro-Serrations
- Fine, Precise, Minimal Trauma
- Highly Polished Blades, Non-Reflective Shanks
- Smooth Finger Rings
- Balanced Weight
- Lifetime Warranty*



TUNGSTEN CARBIDE (TC)

- Gold Rings, Gold Screw
- Atraumatic Micro-Serrations
- Seamless Tungsten Carbide Weld on Knife Edge and Micro-Serrations
- Fine, Precise, Minimal Trauma
- Highly Polished Blades, Non-Reflective Shanks
- Smooth Finger Rings
- Balanced Weight
- Lifetime Warranty*



*Marina Medical offers a lifetime warranty against manufacturing defects. Please contact your account manager should you need any servicing related to wear and tear.

FACELIFT SCISSORS

KAYE



050-318 Kaye Scissors, Curved, Ribbon, 11.5cm
050-318SC Kaye Scissors, SC, Curved, 11.5cm

050-926CER Kaye Freeman Scissors, Ceramic, Curved, 19cm
050-926SC Kaye Freeman Scissors, SC, Curved, 19cm
050-933SC Kaye Scissors, SC, Curved, 15.25cm
050-944CER Kaye Scissors, Ceramic, Curved, 19cm
050-944SC Kaye Scissors, SC, Curved, 19cm

ASTON



050-970CER Aston Scissors, Ceramic, Curved, 20.5cm
050-970SC Aston Scissors, SC, Curved, 20.5cm



- 050-918CER** Gorney Scissors, Ceramic, Curved, 19cm
- 050-918SC** Gorney Scissors, SC, Curved, 19cm
- 050-918SCD** Gorney Scissors, SC, Curved, 19cm, Delicate
- 050-919SC** Gorney Scissors, SC, Straight, 19cm
- 050-950SC** Gorney Freeman Scissors, SC, Straight, 19cm
- 050-951SC** Gorney Freeman Scissors, SC, Straight, 23cm
- 050-952CER** Gorney Freeman Scissors, Ceramic, Curved, 19cm
- 050-952SC** Gorney Freeman Scissors, SC, Curved, 19cm
- 050-953CER** Gorney Freeman Scissors, Ceramic, Curved, 23cm
- 050-953SC** Gorney Freeman Scissors, SC, Curved, 23cm



- 050-948CER** Rees Scissors, Ceramic, Curved, 20.5cm
- 050-948SC** Rees Scissors, SC, Curved, 20.5cm

NASAL SCISSORS

CONVERSE

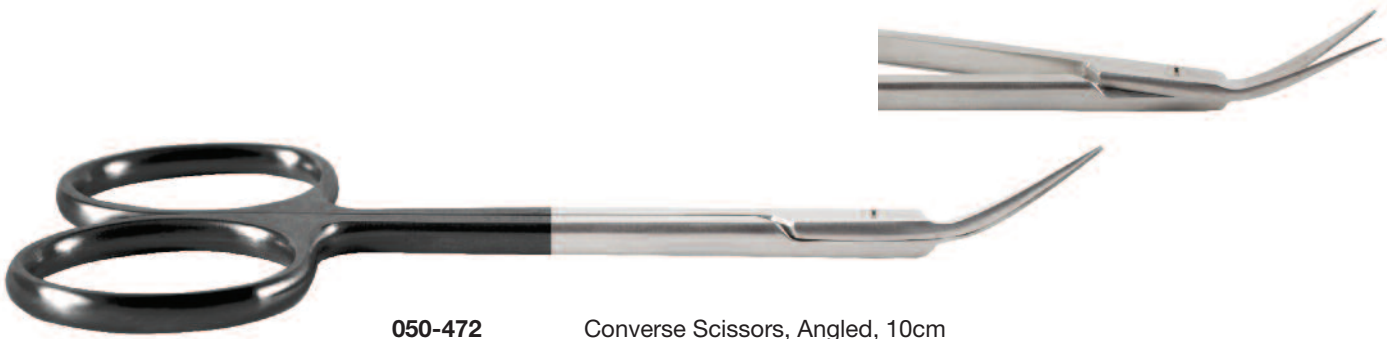

050-472

Converse Scissors, Angled, 10cm

050-472SC

Converse Scissors, SC, Angled, 10cm

COTTLE



050-466SC

Cottle Dorsal Scissors, SC, Angled, 16cm

400-924

Cottle Nasal Scissors, TC, Angled, 16cm

FOMON

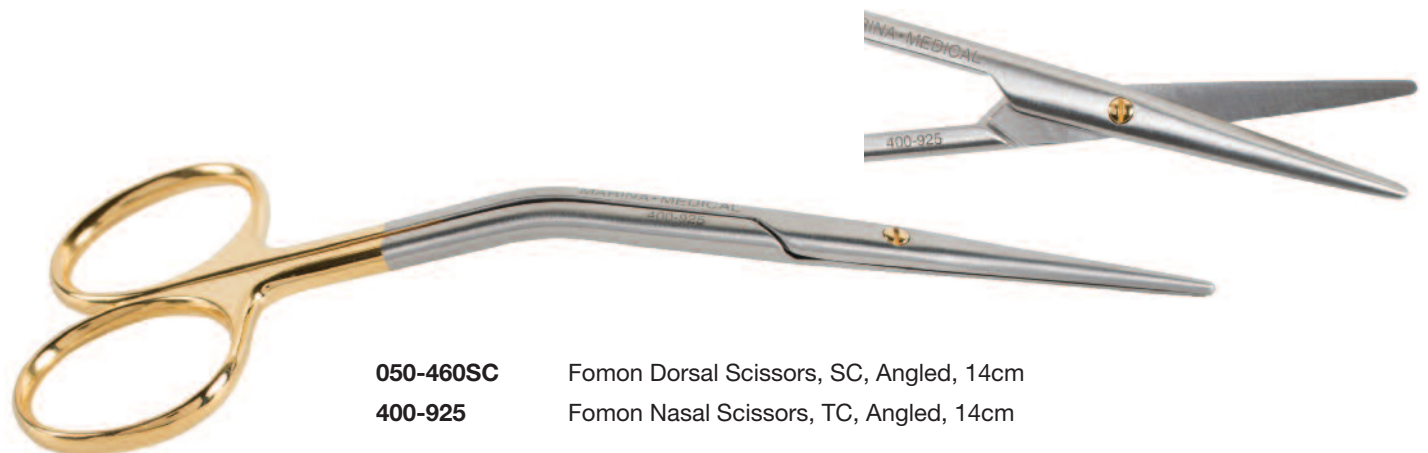

050-460SC

Fomon Dorsal Scissors, SC, Angled, 14cm

400-925

Fomon Nasal Scissors, TC, Angled, 14cm

NASAL SCISSORS

CERKES



050-335SC Cerkes Scissors, SC, Curved, 11.5cm

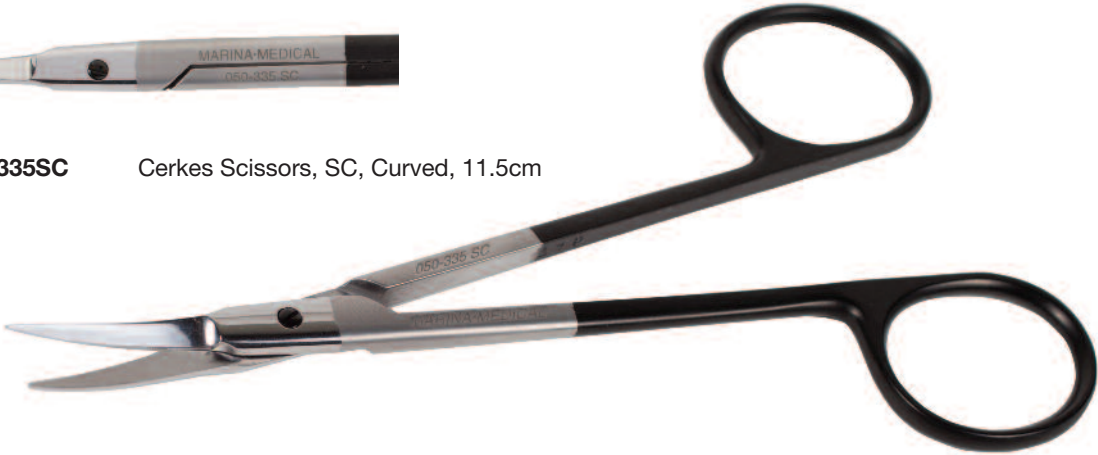

KELLY



400-940 Kelly Scissors, TC, Straight, 16cm
400-941 Kelly Scissors, TC, Curved, 16cm



PECK-JOSEPH



050-224SC Peck-Joseph Scissors, SC, Straight, 14cm
050-226SC Peck-Joseph Scissors, SC, Curved, 14cm



NASAL SCISSORS

CAPLAN NASAL SHEARS



050-480

Caplan Nasal Shears, Angled, 19.5cm

FOMON LOWER LATERAL



050-462

Fomon Lower Lateral Scissors, Strongly Curved, 14cm

GIUNTA



050-976SC

Giunta Scissors, SC, Angled Curved, 13.5cm

WALTER



050-978SC

Walter Scissors, SC, Angled, 14cm

JABALEY



050-450SC Jabaley Scissors, SC, Curved, 12.5cm

GOLDMAN-FOX



050-452SC Goldman Fox Scissors, SC, Curved, 13cm

HEYMAN



050-979SC Heyman Scissors, SC, 18cm

METZENBAUM



- 050-175SC** Metzenbaum Scissors, SC, Straight, 11.5cm
- 050-175SCD** Baby Metz Scissors, SC, Straight, 11.5cm, Delicate
- 050-176SC** Baby Metz Scissors, SC, Curved, 11.5cm
- 050-176SCD** Baby Metz Scissors, SC, Curved, 11.5cm, Delicate
- 050-179SC** Metzenbaum Scissors, SC Straight, 14cm
- 050-179SCD** Metzenbaum Scissors, SC, Delicate, Straight, 14cm
- 050-180SC** Metzenbaum Scissors, SC, Curved, 14cm
- 050-180SCD** Metzenbaum Scissors, SC, Curved, 14cm, Delicate
- 050-181SC** Metzenbaum Scissors, SC, Straight, 18cm
- 050-181SCD** Metzenbaum Scissors, SC, Delicate, Straight, 18cm
- 050-182SC** Metzenbaum Scissors, SC, Curved, 18cm
- 050-182SCD** Metzenbaum Scissors, SC, Delicate, Curved, 18cm
- 050-183SC** Metzenbaum Scissors, SC, Straight, 20.5cm
- 050-183SCD** Metzenbaum Scissors, SC, Delicate, Straight, 20.5cm
- 050-184SC** Metzenbaum Scissors, SC, Curved, 20.5cm
- 050-184SCD** Metzenbaum Scissors, SC, Delicate, Curved, 20.5cm
- 050-188SC** Metzenbaum Scissors, SC, Curved, 23cm
- 050-188SCD** Metzenbaum Scissors, SC, Curved, 23cm, Delicate
- 050-192SCD** Metzenbaum Scissors, SC, Curved, 28cm, Delicate
- 400-515** Metzenbaum Scissors, TC, Straight, 14cm
- 400-518** Metzenbaum Scissors, TC, Straight, 18cm
- 400-520** Metzenbaum Scissors, TC, Straight, 20.5cm
- 400-523** Metzenbaum Scissors, TC, Straight, 23cm
- 400-614** Metzenbaum Scissors, TC, Curved, 14cm
- 400-618** Metzenbaum Scissors, TC, Curved, 18cm
- 400-620** Metzenbaum Scissors, TC, Curved, 20.5cm
- 400-623** Metzenbaum Scissors, TC, Curved, 23cm



- 050-120SC** Mayo Scissors, SC, Straight, 14cm
- 050-122SC** Mayo Scissors, SC, Curved, 14cm
- 050-124SC** Mayo Scissors, SC, Straight, 17cm
- 050-126SC** Mayo Scissors, SC, Curved, 17cm
- 050-128SC** Mayo Scissors, SC, Straight, 23cm
- 050-130SC** Mayo Scissors, SC, Curved, 23cm
- 400-015** Mayo Scissors, TC, Straight, 14cm
- 400-017** Mayo Scissors, TC, Straight, 17cm
- 400-115** Mayo Scissors, TC, Curved, 14cm
- 400-117** Mayo Scissors, TC, Curved, 17cm
- 400-123** Mayo Scissors, TC, Curved, 23cm



050-977SC Slim Scissors, SC, Curved, 14cm

GENERAL SCISSORS

IRIS



- | | |
|------------------|-------------------------------------|
| 050-298 | Baby Iris Scissors, Straight, 9cm |
| 050-299 | Baby Iris Scissors, Curved, 9cm |
| 050-304 | Iris Scissors, Straight, 11.5cm |
| 050-306 | Iris Scissors, Curved, 11.5cm |
| 050-701SC | Iris Scissors, SC, Straight, 11.5cm |
| 050-702SC | Iris Scissors, SC, Curved, 11.5cm |
| 400-912 | Iris Scissors, TC, Straight, 11.5cm |
| 400-913 | Iris Scissors, TC, Curved, 11.5cm |

GRADLE



- | | |
|----------------|---|
| 050-453 | Gradle Scissors, Ribbon, Straight, 10cm |
| 050-455 | Gradle Scissors, Ribbon, Curved, 10cm |

STEVENS



- 050-711SC** Stevens Scissors, SC, Straight, 11.5cm
- 050-712CER** Stevens Scissors, Ceramic, Curved, 11.5cm
- 050-712SC** Stevens Scissors, SC, Curved, 11.5cm

RAGNELL



- 050-426SC** Ragnell Kilner Scissors, SC, Curved, 13cm

GENERAL SCISSORS

WESTCOTT



- 170-121** Westcott Utility Scissors, Straight, 13cm
- 170-122** Westcott Utility Scissors, Curved, 13cm
- 170-124** Westcott Stitch Scissors, Straight, 12cm
- 170-125** Westcott Stitch Scissors, Curved, 12cm

VANNAS



- 170-126** Vannas Micro Iris Scissors, Straight, 5mm Blades, 8cm
- 170-128** Vannas Micro Iris Scissors, Curved, 5mm Blades, 8cm



050-320

O'Brien Scissors, Angled, 10cm



050-414

Spencer Stitch Scissors, Straight, 9cm

GENERAL SCISSORS

OPERATING

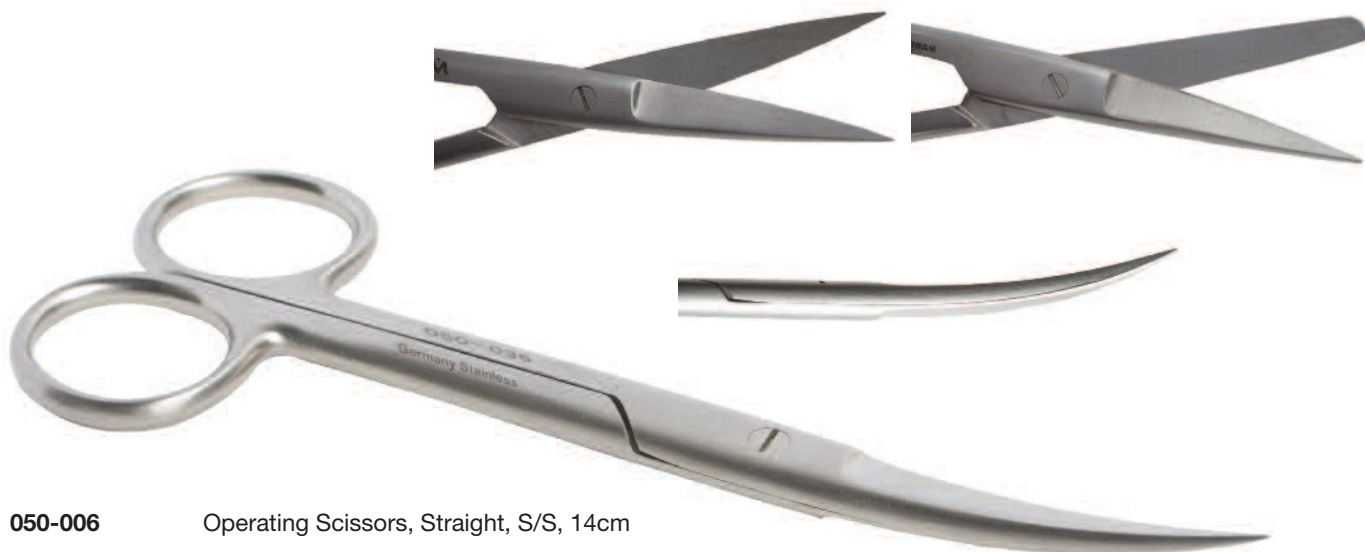

- 050-006** Operating Scissors, Straight, S/S, 14cm
- 050-016** Operating Scissors, Straight, B/S, 14cm
- 050-036** Operating Scissors, Curved, S/S, 14cm
- 050-046** Operating Scissors, Curved, B/S, 14cm

LISTER



- 050-514** Lister Bandage Scissors, 14cm
- 050-516** Lister Bandage Scissors, 18cm